

Multi Channel AV Receiver

Operating Instructions

STR-DA3500ES

WARNING

To reduce the risk of fire or electric shock, do not expose this apparatus to rain or moisture.

To reduce the risk of fire, do not cover the ventilation opening of the apparatus with newspapers, tablecloths, curtains, etc. Do not place the naked flame sources such as lighted candles on the apparatus.

Do not install the appliance in a confined space, such as a bookcase or built-in cabinet.

To reduce the risk of fire or electric shock, do not expose this apparatus to dripping or splashing, and do not place objects filled with liquids, such as vases, on the apparatus.

As the main plug is used to disconnect the unit from the mains, connect the unit to an easily accessible AC outlet. Should you notice an abnormality in the unit, disconnect the main plug from the AC outlet immediately.

Do not expose batteries or apparatus with battery-installed to excessive heat such as sunshine, fire or the like.

The unit is not disconnected from the mains as long as it is connected to the AC outlet, even if the unit itself has been turned off.

Excessive sound pressure from earphones and headphones can cause hearing loss.

For customers in the United States and Canada



This symbol is intended to alert the user to the presence of the Hot Surface that may be hot if it is touched during the normal operation.



ENERGY STAR[®] is a U.S. registered mark. As an ENERGY STAR[®] partner, Sony Corporation has determined that this product meets the ENERGY STAR[®] guidelines for energy efficiency.

For customers in the United States

Owner's Record

The model and serial numbers are located on the rear of the unit. Record these numbers in the space provided below. Refer to them whenever you call upon your Sony dealer regarding this product.

Model No. _____ Serial No. _____



This symbol is intended to alert the user to the presence of uninsulated "dangerous voltage" within the product's enclosure that may be of sufficient magnitude to constitute a risk of electric shock to persons.



This symbol is intended to alert the user to the presence of important operating and maintenance (servicing) instructions in the literature accompanying the appliance.

Important Safety Instructions

- 1) Read these instructions.
- 2) Keep these instructions.
- 3) Heed all warnings.
- 4) Follow all instructions.
- 5) Do not use this apparatus near water.
- 6) Clean only with dry cloth.
- 7) Do not block any ventilation openings. Install in accordance with the manufacturer's instructions.
- 8) Do not install near any heat sources such as radiators, heat registers, stoves, or other apparatus (including amplifiers) that produce heat.
- 9) Do not defeat the safety purpose of the polarized or grounding-type plug. A polarized plug has two blades with one wider than the other. A grounding type plug has two blades and a third grounding prong. The wide blade or the third prong are provided for your safety. If the provided plug does not fit into your outlet, consult an electrician for replacement of the obsolete outlet.
- 10) Protect the power cord from being walked on or pinched particularly at plugs, convenience receptacles, and the point where they exit from the apparatus.
- 11) Only use attachments/accessories specified by the manufacturer.

- 12) Use only with the cart, stand, tripod, bracket, or table specified by the manufacturer, or sold with the apparatus. When a cart is used, use caution when moving the cart/apparatus combination to avoid injury from tip-over.



- 13) Unplug this apparatus during lightning storms or when unused for long periods of time.
- 14) Refer all servicing to qualified service personnel. Servicing is required when the apparatus has been damaged in any way, such as power-supply cord or plug is damaged, liquid has been spilled or objects have fallen into the apparatus, the apparatus has been exposed to rain or moisture, does not operate normally, or has been dropped.

The following FCC statement applies only to the version of this model manufactured for sale in the U.S.A. Other versions may not comply with FCC technical regulations.

NOTE:

This equipment has been tested and found to comply with the limits for a Class B digital device, pursuant to Part 15 of the FCC Rules. These limits are designed to provide reasonable protection against harmful interference in a residential installation.

This equipment generates, uses and can radiate radio frequency energy and, if not installed and used in accordance with the instructions, may cause harmful interference to radio communications. However, there is no guarantee that interference will not occur in a particular installation. If this equipment does cause harmful interference to radio or television reception, which can be determined by turning the equipment off and on, the user is encouraged to try to correct the interference by one or more of the following measures:

- Reorient or relocate the receiving antenna.
- Increase the separation between the equipment and receiver.
- Connect the equipment into an outlet on a circuit different from that to which the receiver is connected.
- Consult the dealer or an experienced radio/TV technician for help.

CAUTION

You are cautioned that any changes or modifications not expressly approved in this manual could void your authority to operate this equipment.

To reduce the risk of electric shock, the speaker cord should be connected to the apparatus and the speakers in accordance with the following instructions.

- 1) Disconnect the AC power cord from the MAINS.
- 2) Strip 10 to 15 mm of the wire insulation of the speaker cord.
- 3) Connect the speaker cord to the apparatus and the speakers carefully so as not to touch the core of speaker cord by hand. Also disconnect the AC power cord from the MAINS before disconnecting the speaker cord from the apparatus and the speakers.

About This Manual

- The instructions in this manual are for model STR-DA3500ES. Check your model number by looking at the lower right corner of the front panel.
- The instructions in this manual describe the controls on the supplied remote. You can also use the controls on the receiver if they have the same or similar names as those on the remote.

On Copyrights

This receiver incorporates Dolby* Digital and Pro Logic Surround and the DTS** Digital Surround System.

- * Manufactured under license from Dolby Laboratories. Dolby and the double-D symbol are trademarks of Dolby Laboratories.
- ** Manufactured under license under U.S. Patent #'s: 5,451,942; 5,956,674; 5,974,380; 5,978,762; 6,226,616; 6,487,535; 7,212,872; 7,333,929; 7,392,195; 7,272,567 & other U.S. and worldwide patents issued & pending. DTS is a registered trademark and the DTS logos, Symbol, DTS-HD and DTS-HD Master Audio are trademarks of DTS, Inc. © 1996-2008 DTS, Inc. All Rights Reserved.

“Neural-THX” and “NEURAL-THX” introduced in the Operating Instructions and displayed in the display window and on the GUI menu screen mean Neural-THX Surround.

This product using Neural-THX® Surround is manufactured under license from Neural Audio Corporation and THX Ltd. Sony Corporation hereby grants the user a non-exclusive, non-transferable, limited right of use to this product under USA and foreign patent, patent pending and other technology or trademarks owned by Neural Audio Corporation and THX Ltd. “Neural Surround”, “Neural Audio”, “Neural” and “NRL” are trademarks and logos owned by Neural Audio Corporation, THX is a trademark of THX Ltd., which may be registered in some jurisdictions. All rights reserved.

This receiver incorporates High-Definition Multimedia Interface (HDMI™) technology.

HDMI, the HDMI logo and High-Definition Multimedia Interface are trademarks or registered trademarks of HDMI Licensing LLC.

SIRIUS, XM and all related marks and logos are trademarks of Sirius XM Radio Inc. and its subsidiaries. All rights reserved.

The font type (Shin Go R) installed in this receiver is provided by MORISAWA & COMPANY LTD. These names are the trademarks of MORISAWA & COMPANY LTD., and the copyright of the font also belongs to MORISAWA & COMPANY LTD.

iPod is a trademark of Apple Inc., registered in the U.S. and other countries.

All other trademarks and registered trademarks are of their respective holders. In this manual, ™ and ® marks are not specified.

The Bluetooth word mark and logos are owned by the Bluetooth SIG, Inc. and any use of such marks by Sony Corporation is under license.

Other trademarks and trade names are those of their respective owners.

“M-crew Server” is a trademark of Sony Corporation.

“x.v.Color (x.v.Colour)” and “x.v.Color (x.v.Colour)” logo are trademarks of Sony Corporation.

“BRAVIA” is a trademark of Sony Corporation.

Table of Contents

Getting Started

Description and location of parts	7
1: Installing the speakers	15
2: Connecting the speakers	17
3: Connecting the TV	19
4a: Connecting the audio components	20
4b: Connecting the video components	25
5: Connecting the antennas (aerials)	36
6: Preparing the receiver and the remote	37
7: Operating the receiver using the GUI (Graphical User Interface)	40
8: Setting the speakers	43
9: Calibrating the appropriate speaker settings automatically (Auto Calibration)	44

Playback

Selecting a component	50
Listening to a Super Audio CD/CD	52
Watching a DVD/Blu-ray Disc	53
Enjoying video games	54
Watching video	55

Amplifier Operations

Settings for the audio (Audio settings menu)	56
Settings for the video (Video settings menu)	57
Settings for HDMI (HDMI settings menu)	57
Settings for the system (System settings menu)	58

Enjoying Surround Sound

Enjoying a pre-programmed sound field	59
Resetting sound fields to the initial settings	64
Enjoying the surround effect at low volume levels (NIGHT MODE)	65

Advanced Speakers Set Up

Adjusting the speaker settings manually	65
Adjusting the equalizer	70

Tuner Operations

Listening to FM/AM radio	71
Listening to Satellite Radio	74

“BRAVIA” Sync features

Using “BRAVIA” Sync features	84
Preparing Control for HDMI function	86
Playing back components with one-touch operation (One-Touch Play)	87
Enjoying the TV sound from the speakers connected to the receiver (System Audio Control)	88
Turning off the receiver with the TV (System Power-Off)	88
Enjoying movies with the optimum sound field (Theater Mode Sync)	89
24p Auto Sound Sync	89

Using Multi-zone Features

What you can do with the Multi-zone function	90
Making a multi-zone operation	91
Switching the zone setting of the remote ...	95

Other Operations

Converting analog video input signals	96
Enjoying the sound/images from the components connected to the DIGITAL MEDIA PORT	97
Naming inputs	101
Switching between digital and analog audio (INPUT MODE)	101
Enjoying the sound/images from other inputs	102
Changing the display window	105
Using the sleep timer	108
Recording using the receiver	109
Using a bi-amplifier connection	110
Operating without connecting to the TV	111

Using the Remote

Operating each component using the multi function remote	122
Programming the remote	124
Performing several commands in sequence automatically (Macro Play)	128
Setting remote control codes that are not stored in the remote	130
Clearing all the contents of the remote's memory	131

Additional Information

Glossary	132
Precautions	135
Troubleshooting	136
Specifications	141
Index	144

Description and location of parts

Front panel

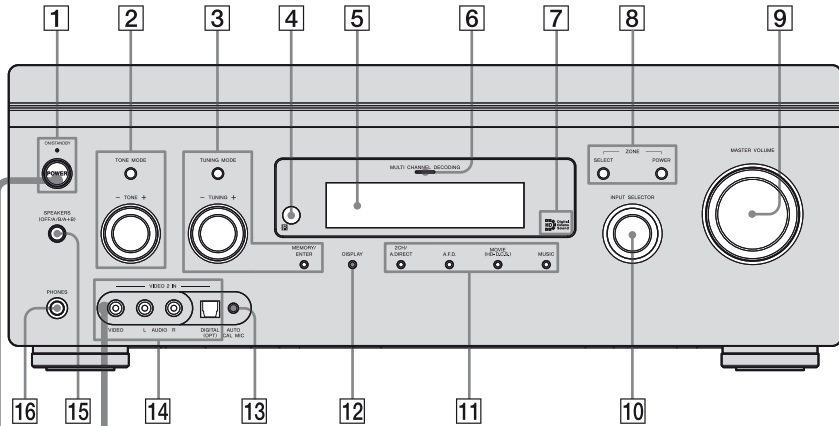

To remove the cover

Press PUSH.

When you remove the cover, keep it out of reach from children.



Status of the POWER button

Off

The receiver is turned off (the ON/STANDBY lamp lights off) (initial setting).

Press POWER to turn the receiver on.

You cannot turn the receiver on using the remote.

On/Standby

Press I/O on the remote to

- turn the receiver on (the ON/STANDBY lamp lights up in green).

- set the receiver to standby mode (the ON/STANDBY lamp lights up in red).

When you press POWER on the receiver, the receiver will be turned off.



Name	Function
1 POWER	Press to turn the receiver on or off.
ON/STANDBY lamp	Shows the status of the receiver.
2 TONE MODE TONE +/-	Adjust the bass and treble for the front, center and surround/surround back channels. Press TONE MODE repeatedly to select the item you want, then turn TONE +/- to adjust the level (page 115).
3 TUNING MODE TUNING +/- MEMORY/ ENTER	Press to operate a tuner (FM/AM) and satellite radio (XM/SIRIUS) (page 119-122).
4 Remote sensor	Receives signals from remote commander.
5 Display window	The current status of the selected component or a list of selectable items appears here (page 106).
6 MULTI CHANNEL DECODING lamp	Lights up when multi channel audio signals are decoded.
7 HD Digital Cinema Sound lamp	Lights up when a sound field with HD-D.C.S. is selected (page 63).
8 ZONE POWER/ SELECT	Press ZONE SELECT repeatedly to select zone 2, zone 3 or main zone. Each time you press ZONE POWER, the output signals for the selected zone will be turned on or off (page 90).

Name	Function
9 MASTER VOLUME	Turn to adjust the volume level of all speakers at the same time.
10 INPUT SELECTOR	Turn to select the input source to play back. To select the input source for zone 2 or zone 3, press ZONE SELECT (8) to select zone 2 or zone 3 first, then turn INPUT SELECTOR to select the input source.
11 2CH/A.DIRECT	Press to select a sound field (page 119) or to switch the audio of the selected input to analog signal without any adjustment (page 119).
A.F.D.	Press to select a sound field (page 59).
MOVIE (HD-D.C.S.)	
MUSIC	
12 DISPLAY	Press repeatedly to select information displayed on the display window.
13 AUTO CAL MIC jack	Connects to the supplied optimizer microphone for the Digital Cinema Auto Calibration function (page 45).
14 VIDEO 2 IN jacks	Connect to audio/video component such as a camcorder or video game.
15 SPEAKERS (OFF/A/B/A+B)	Switch to OFF, A, B, A+B of the front speakers (page 44).
16 PHONES jack	Connects to headphones.

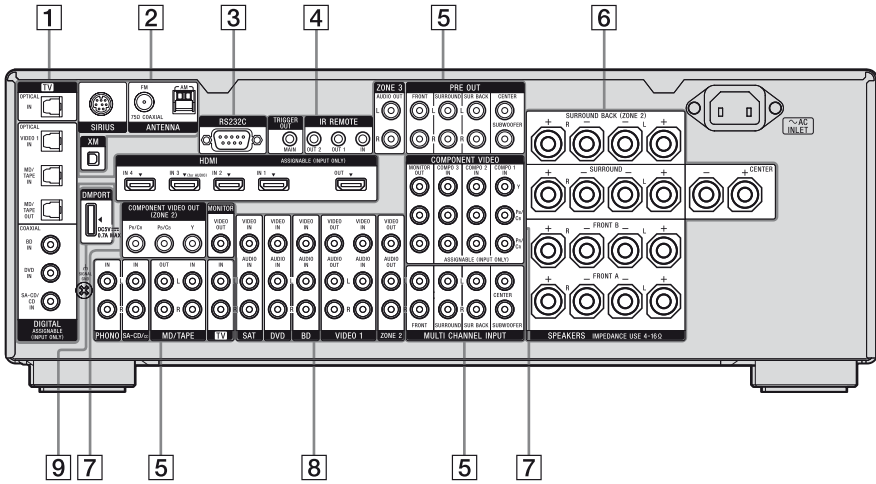



Rear panel



1 DIGITAL INPUT/OUTPUT section

	OPTICAL IN/OUT jacks	Connect to a DVD player, Super Audio CD player, etc. The COAXIAL jack provides a better sound quality (page 19, 21, 29, 30).
	COAXIAL IN jacks	
	HDMI IN/OUT* jacks	Connect to a DVD player, Blu-ray disc player, or a satellite tuner, etc. The image is output to a TV or a projector while the sound can be output from a TV or/and speakers connected to this receiver (page 19, 26).



2 ANTENNA section

	FM ANTENNA jack	Connects to the supplied FM wire antenna (aerial) (page 36).
	AM ANTENNA jack	Connects to the supplied AM loop antenna (aerial) (page 36).
	XM jack	Connects to the XM Mini Tuner and Home Dock (not supplied) (page 75).
	SIRIUS jack	Connects to a SiriusConnect Home tuner (not supplied) (page 75).



3 RS232C port

	Used for maintenance and service.
---	-----------------------------------

4 Control jacks for Sony equipment and other external components

	IR REMOTE IN/OUT jacks	Connect to an IR repeater (page 91).
	TRIGGER OUT jack	Connects to an interlock on/off of the power supply of other 12V TRIGGER compliant components, or the amplifier/receiver of zone 2 or zone 3 (page 94).

5 AUDIO INPUT/OUTPUT section

	White (L) AUDIO IN/OUT jacks	Connect to a tape deck or MD deck, etc. (page 19, 21, 24).
	Red (R)	

	MULTI CHANNEL INPUT jacks	Connect to a Super Audio CD player or DVD player with an analog audio jack for 7.1 channel or 5.1 channel sound (page 23).
--	---------------------------	--

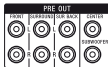

	PRE OUT jacks	Connect to an external power amplifier (page 17).
--	---------------	---

	ZONE 3 AUDIO OUT jacks	Connects to the component in zone 3 (page 92).
---	------------------------	--



6 SPEAKERS section

		Connects to speakers (page 17).
--	--	---------------------------------

7 COMPONENT VIDEO INPUT/OUTPUT section

	Green (Y) Y, P _B /C _B , P _R /C _R IN/OUT* jacks	Connect to a DVD player, TV, satellite tuner, etc. (page 19, 29, 30, 31).
	Blue (P _B /C _B) jacks	
	Red (P _R /C _R) jacks	

8 VIDEO/AUDIO INPUT/OUTPUT section

	White (L) AUDIO IN/OUT jacks	Connect to a VCR or a DVD player, etc. (page 19, 29, 30, 31, 32).
	Red (R)	

	Yellow VIDEO IN/OUT* jacks	
---	----------------------------	--

	AUDIO OUT jacks VIDEO OUT jack	Connects to the component in zone 2 (page 91).
---	-----------------------------------	--

9 DMPORT

		Connects to a Sony DIGITAL MEDIA PORT adapter (page 21).
---	--	--

* You can watch the selected input image when you connect the MONITOR OUT or HDMI OUT jack to a TV (page 19). You can operate this receiver using a GUI (Graphical User Interface) (page 40).

Remote commander

You can use the supplied remote commander to operate the receiver and to control the Sony audio/video components that the remote is assigned to operate (page 124).



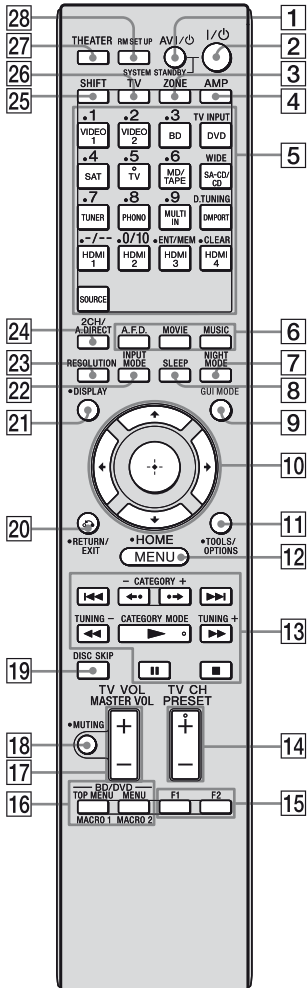











Multi function remote commander (RM-AAL026)



Name	Function
1 AV I/⏻ (on/standby)	Press to turn on or off the audio/video components that the remote is assigned to operate (page 124). To turn the TV on or off, press TV (26), then press AV I/⏻. If you press the I/⏻ (2) at the same time, it will turn off the receiver and other Sony components (SYSTEM STANDBY). Note The function of the AV I/⏻ switch changes automatically each time you press the input button (5).
2 I/⏻ (on/standby)	Press to turn the receiver on or set it to standby mode. If zone 2 or zone 3 is selected, only the main receiver is turned on or off with this button. To turn off all Sony components including an amplifier in zone 2 or zone 3, press I/⏻ and AV I/⏻ (1) at the same time (SYSTEM STANDBY). To save the power in standby mode, set "Control for HDMI" (page 57) and "Installer Mode" to "OFF" (page 58).
3 ZONE	Press to switch the zone 2 or zone 3 operation (page 90).
4 AMP	Press to enable the receiver operation (page 40).
5 Input buttons (TV ^b)	Press one of the buttons to select the component you want to use. When you press any of the input buttons, the receiver turns on. The buttons are factory assigned to control Sony components (page 51). You can program the remote to control non-Sony components following the steps in "Programming the remote" (page 124).

continued

Name	Function
Numeric buttons (number 5^b)	Press SHIFT (25), then press numeric buttons to <ul style="list-style-type: none"> – preset/tune to preset stations. – select the track numbers of the DVD player, MD deck, etc. Press 0/10 to select track number 10. – select the channel numbers of the VCR, satellite tuner, etc. Press TV (26), then press the numeric buttons to select the TV channels.
TV INPUT	Press TV (26), then press TV INPUT to select the input signal (TV input or video input).
WIDE	Press TV (26), then press WIDE repeatedly to select the wide picture mode.
D.TUNING	Press SHIFT (25), then press D.TUNING to enter direct tuning mode (page 119, 121).
-/-	Press SHIFT (25), then press -/- to select the channel entry mode, either one or two digit of the VCR, satellite tuner, etc. Press TV (26), then press -/- to select the channel entry mode of the TV.
ENT/MEM	Press SHIFT (25), then press ENT/MEM to <ul style="list-style-type: none"> – enter the value after selecting a channel, disc or track using the numeric buttons. – to store a station during tuner operation. Press TV (26), then press ENT/MEM to enter the value of Sony TV.
CLEAR	Press SHIFT (25), then press CLEAR to <ul style="list-style-type: none"> – clear a mistake when you press the incorrect numeric button. – return to continuous playback, etc. of the satellite tuner, DVD player, etc.
6 A.F.D.	Press to select a sound field (page 119).
MOVIE	
MUSIC	

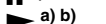
Name	Function
7 NIGHT MODE	Press to activate the NIGHT MODE function (page 65).
8 SLEEP	Press to activate the sleep timer function and the duration which the receiver turns off automatically (page 108).
9 GUI MODE	Press to switch the display mode of the menu between GUI MODE (to display the menu on the TV screen) and DISPLAY MODE (to display the menu in the display window).
10	 Press  /  /  /  to select the menu items. Then press  to enter the selection.
11 TOOLS/OPTIONS	Press to display and select the items from the option menus of the receiver, DVD player, Blu-ray disc player, etc. Press TV (26), then press TOOLS/OPTIONS to display the options of the Sony TV.
12 MENU	Press AMP (4), then press MENU to display the menu to operate the receiver. Press MENU to display the menu to operate the audio/video components.
HOME	Press TV (26), then press HOME to display the TV's menu. Then use  /  /  /  and  to perform menu operations.
13	 a)  a)  a) b)  a)
←/./→	Press to select an album.
CATEGORY +/-	Press to select the category for satellite tuner (page 121).
CATEGORY MODE^b	Press to select the category mode for satellite tuner (page 121).
TUNING +/-	Press to select a station (page 119, 121).

Name	Function
14 PRESET +^{b)}/-	Press to register FM/AM/satellite tuner stations or to select preset stations.
TV CH +^{b)}/-	Press TV (26), then press TV CH +/- to operate the TV, satellite tuner, VCR, etc.
15 F1/F2	Press to select a component to operate. <ul style="list-style-type: none"> HDD/DISC combo F1: HDD F2: DVD, Blu-ray disc DVD/VHS combo F1: DVD, Blu-ray disc F2: VHS
16 BD/DVD TOP MENU, MENU	Press to display the menu of the DVD or Blu-ray disc on the TV screen. Then, use \blacktriangle / \blacktriangledown / \blacktriangleleft / \blacktriangleright and \oplus to perform menu operations (page 123).
MACRO 1, MACRO 2	Press MACRO 1 or MACRO 2 to set up the macro function (page 128).
17 MASTER VOL +/-	Press to adjust the volume level of all speakers at the same time.
TV VOL +/-	Press TV (26), then press TV VOL +/- to adjust the volume level of the TV.
18 MUTING	Press to turn off the sound temporarily. Press MUTING again to restore the sound. Press TV (26), then press MUTING to activate the TV's muting function.
19 DISC SKIP	Press to skip a disc when using a multi-disc changer.
20 RETURN/EXIT \blacktriangleleft	Press to return to the previous menu or exit the menu while the menu or on-screen guide of the VCR, DVD player, etc. is displayed on the TV screen. Press TV (26), then press RETURN/EXIT \blacktriangleleft to return to the previous menu or exit the TV's menu while the menu is displayed on the TV screen.
21 DISPLAY	Press to select information displayed in the display window, TV screen of the VCR, satellite tuner, etc. Press TV (26), then press DISPLAY to display TV's information on the TV screen.

Name	Function
22 INPUT MODE	Press to select the input mode when the same components are connected to both digital and analog jacks (page 101).
23 RESOLUTION	Press repeatedly to change the resolution of signals output from the HDMI OUT or COMPONENT VIDEO MONITOR OUT jack (page 96).
24 2CH/A.DIRECT	Press to select a sound field (page 119) or to switch the audio of the selected input to analog signal without any adjustment (page 119).
25 SHIFT	Press to light up the button to activate the buttons with pink printing.
26 TV	Press to light up the button to enable the TV operation (buttons with yellow printing).
27 THEATER	Press to turn the Theater mode on and off when connecting the receiver to products featuring "BRAVIA" Sync. Note This button will only function if your TV is compatible with Theater Mode. Refer to the operating instructions supplied with the TV for details.
28 RM SET UP	Press to set up the remote.

^{a)} See the table on page 123 for information on the buttons that you can use to control each component.

^{b)} The TV/5, \blacktriangleright /CATEGORY MODE and PRESET +/TV CH + buttons have tactile dots. Use the tactile dots as references when operating the receiver.

Notes



- Some functions explained in this section may not work depending on the model.
- The above explanation is intended to serve as an example only. Therefore, depending on the component, the above operation may not be possible or may operate differently than described.

continued

Simple remote commander (RM-AAU039)

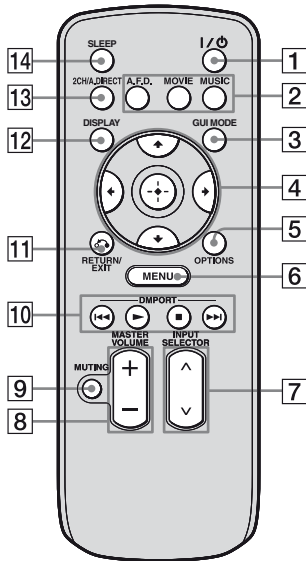
This remote can only be used to operate the receiver. You can control the main functions of the receiver with simple operations using this remote.



Name	Function
7 INPUT SELECTOR ▲/▼	Press to select the input source to play back.
8 MASTER VOLUME +/-	Press to adjust the volume level.
9 MUTING	Press to turn off the sound temporarily. Press the button again to restore the sound.
10 DMPORT	Press to operate the component connected to the DIGITAL MEDIA PORT adapter (page 50).
	Starts play.
	Stops play.
	Skips tracks.
11 RETURN/EXIT ↶	Press to return to the previous menu or exit the menu.
12 DISPLAY	Press to select information displayed in the display window.
13 2CH/A.F.DIRECT	Press to select sound field (page 119) or to switch the audio of the selected input to analog signal without any adjustment (page 119).
14 SLEEP	Press to activate the sleep timer function and the duration which the receiver turns off automatically (page 108).

Name	Function
1 I/⏻ (on/standby)	Press to turn a receiver on or off.
2 A.F.D. MOVIE MUSIC	Press to select a sound field (page 119).
3 GUI MODE	Press to display the menu on the TV screen to operate the receiver.
4  ▲/▼/◀/▶	After pressing GUI MODE (3), press ▲/▼/◀/▶ to select the menu item. Then press ⊕ to enter the selection.
5 OPTIONS	Press to display and select items from option menus.
6 MENU	Press to display the menu to operate the receiver.

1: Installing the speakers

This receiver allows you to use a 7.1 channel system (7 speakers and one subwoofer).

Enjoying a 5.1/7.1 channel system

To fully enjoy theater-like multi channel surround sound requires five speakers (two front speakers, a center speaker, and two surround speakers) and a subwoofer (5.1 channel system).

Example of a 5.1 channel speaker system configuration

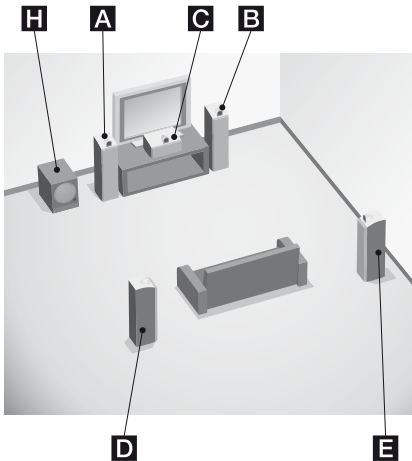

- A** Front speaker (left)
- B** Front speaker (right)
- C** Center speaker
- D** Surround speaker (left)
- E** Surround speaker (right)
- H** Subwoofer

You can enjoy high fidelity reproduction of DVD or Blu-ray Disc software recorded sound in the Surround EX format if you connect one additional surround back speaker (6.1 channel system) or two surround back speakers (7.1 channel system).

Example of a 7.1 channel speaker system configuration

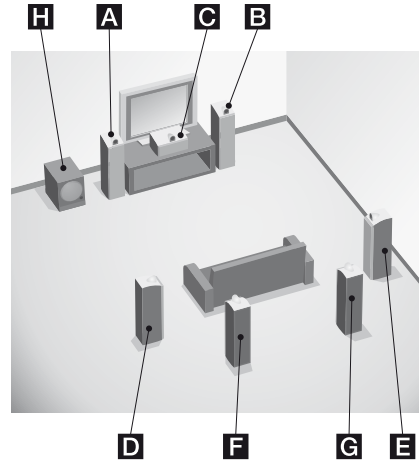

- A** Front speaker (left)
- B** Front speaker (right)
- C** Center speaker
- D** Surround speaker (left)
- E** Surround speaker (right)
- F** Surround back speaker (left)
- G** Surround back speaker (right)
- H** Subwoofer

Tips

- The angle **A** should be the same.

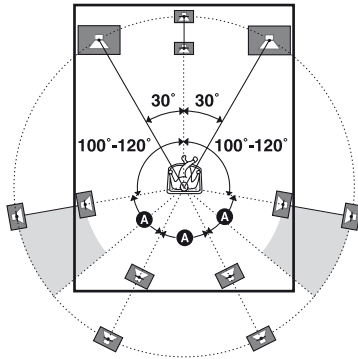

- When you connect a 6.1 channel speaker system, place the surround back speaker behind the seating position.

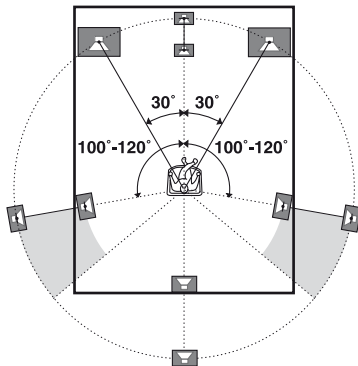

- Since the subwoofer does not emit highly directional signals, you can place it wherever you want.

2: Connecting the speakers

Before connecting cords, make sure to disconnect the AC power cord (mains lead).

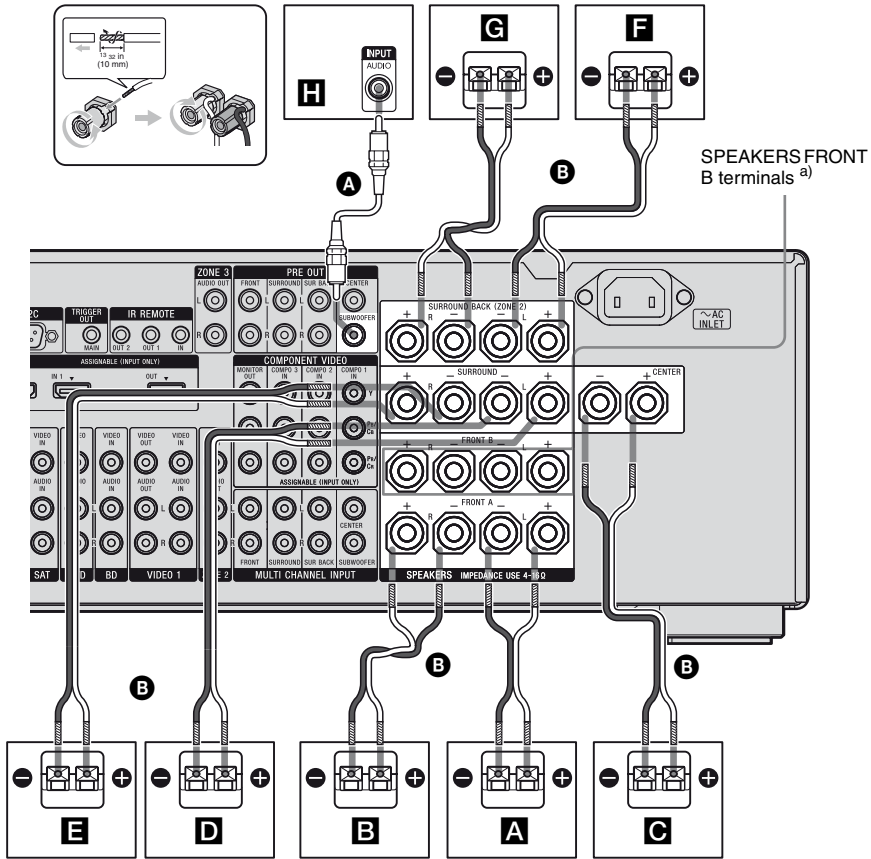

- A** Monaural audio cord (not supplied)
- B** Speaker cords (not supplied)

- A** Front speaker A (Left)
- B** Front speaker A (Right)
- C** Center speaker
- D** Surround speaker (Left)
- E** Surround speaker (Right)
- F** Surround back speaker (Left)^{b)}
- G** Surround back speaker (Right)^{b)}
- H** Subwoofer^{c)}

^{a)} If you have an additional front speaker system, connect them to the SPEAKERS FRONT B terminals. You can select the front speaker system you want to use with the SPEAKERS (OFF/A/B/A+B) button on the front panel (page 44).

continued

- b) If you connect only one surround back speaker, connect it to the SPEAKERS SURROUND BACK L terminals.
- c) When you connect a subwoofer with an auto standby function, turn off the function when watching movies. If the auto standby function is set to on, it turns to standby mode automatically based on the level of the input signal to a subwoofer, then sound may not be output.

Notes

- When you connect all the speakers with a nominal impedance of 8 ohms or higher, set “Impedance” in the Speaker settings menu to “8 Ω”. In other connections, set it to “4 Ω”. For details, see “8: Setting the speakers” (page 43).
- Before connecting the AC power cord (mains lead), make sure that metallic wires of the speaker cords are not touching each other between the SPEAKERS terminals.

Tip

To connect certain speakers to another power amplifier, use the PRE OUT jacks. The same signal is output from both the SPEAKERS terminals and the PRE OUT jacks. For example, if you want to connect just the front speakers to another amplifier, connect that amplifier to the PRE OUT FRONT L and R jacks.

ZONE 2 connection

You can assign the SPEAKERS SURROUND BACK terminals **F** and **G** to the speakers of the zone 2. Set “Sur Back Assign” to “ZONE2” in the Speaker settings menu. See “Using Multi-zone Features” (page 90) for details on connection and operation in zone 2.

3: Connecting the TV

You can watch the selected input image when you connect the MONITOR OUT or HDMI OUT jack to a TV. You can operate this receiver using a GUI (Graphical User Interface).

It is not necessary to connect all the cords. Connect the audio and video cords according to the jacks of your components. Before connecting cords, be sure to disconnect the AC power cord (mains lead).

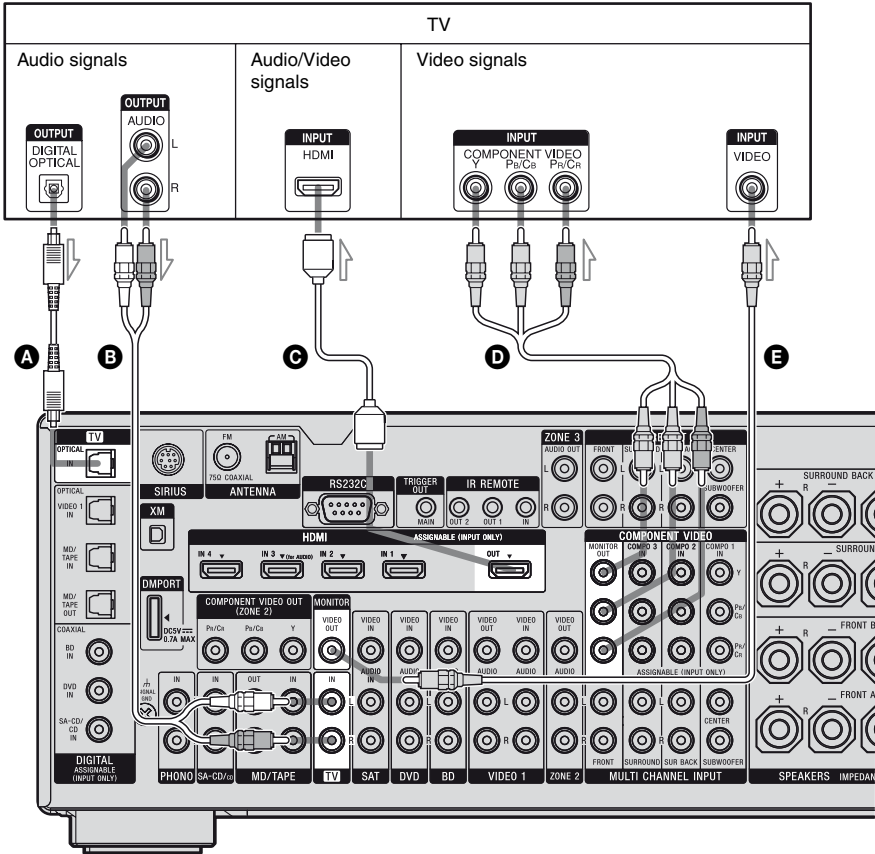

- A** Optical digital cord (not supplied)
- B** Audio cord (not supplied)
- C** HDMI cable (not supplied)
- D** Component video cord (not supplied)
- E** Video cord (not supplied)

Sony recommends that you use an HDMI-authorized cable or Sony HDMI cable.

continued

Notes

- Be sure to turn on the receiver when the video and audio signals of a playback component are being output to a TV via the receiver. Unless the power is turned on, neither video nor audio signals will be transmitted.
- Depending on the status of the connection between the TV and the antenna (aerial), the image on the TV screen may be distorted. In this case, place the antenna (aerial) farther away from the receiver.
- Do not bend or tie optical digital cord.
- When connecting optical digital cords, insert the plugs straight in until they click into place.

Tips

- The receiver has a video conversion function. For details, see “Notes on converting video signals” (page 34).
- The sound of the TV is output from the speakers connected to the receiver if you connect the audio output jack of the TV and the TV IN jacks of the receiver. In this configuration, set the audio output jack of the TV to “Fixed” if it can be switched between either “Fixed” or “Variable”.
- The screen saver is activated when the GUI menu is displayed on the TV screen and there has been no operation attempted for 15 minutes.
- All the digital audio jacks are compatible with 32 kHz, 44.1 kHz, 48 kHz and 96 kHz sampling frequencies.

4a: Connecting the audio components

How to hook up your components

This section describes how to hook up your components to this receiver. Before you begin, see “Component to be connected” below for the pages which describe how to connect each component. Before connecting cords, be sure to disconnect the AC power cord (mains lead). After hooking up all your components, proceed to “5: Connecting the antennas (aerials)” (page 36).

Component to be connected		Page
Super Audio CD player, CD player	With digital audio output	21
	With multi channel audio output	23
	With analog audio output only	24
MD deck	With digital audio output	21
	With analog audio output only	24
Tape deck, Analog disc turntable		24
DIGITAL MEDIA PORT adapter		21

Notes

- When connecting optical digital cords, insert the plugs straight in until they click into place.
- Do not bend or tie optical digital cords.

Tip

All the digital audio jacks are compatible with 32 kHz, 44.1 kHz, 48 kHz, and 96 kHz sampling frequencies.

Connecting components with digital audio input/output jacks

The following illustration shows how to connect a Super Audio CD player, CD player, an MD deck and DIGITAL MEDIA PORT adapter.

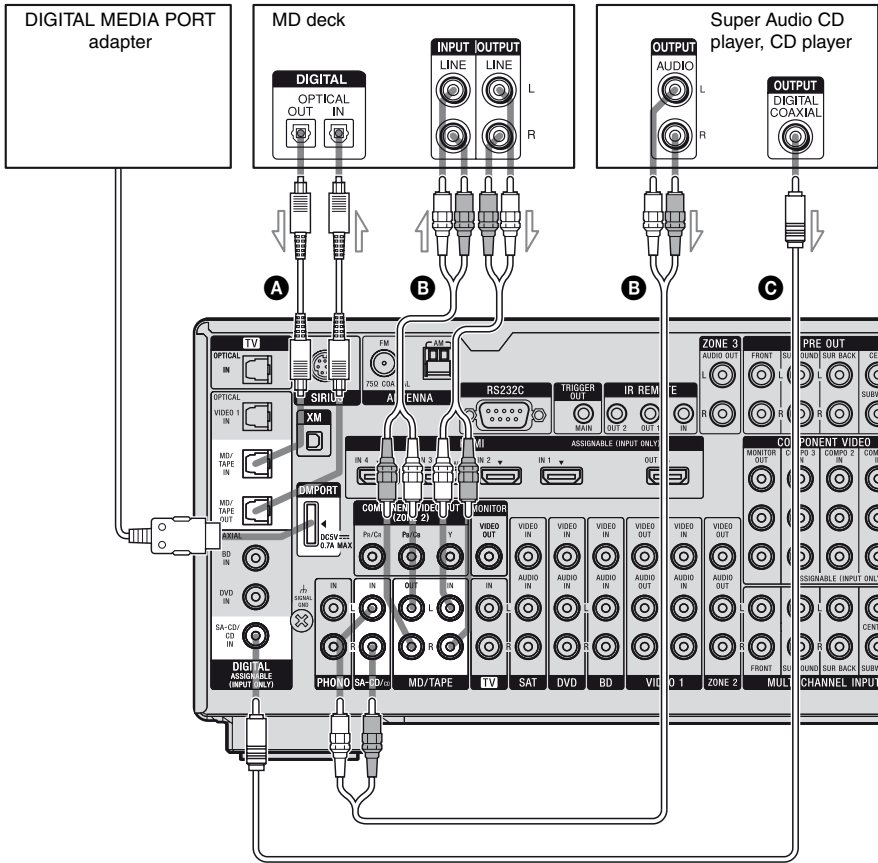

- A** Optical digital cord (not supplied)
- B** Audio cord (not supplied)
- C** Coaxial digital cord (not supplied)

Notes on connecting a DIGITAL MEDIA PORT adapter

- When connecting the DIGITAL MEDIA PORT adapter, be sure the connector is inserted with the arrow mark facing towards the arrow mark on the DMPORT jack.
- Be sure to make DMPORT connections firmly, insert the connector straight in.
- As the connector of the DIGITAL MEDIA PORT adapter is fragile, be sure to handle with care when placing or moving the receiver.
- To disconnect the DIGITAL MEDIA PORT adapter, squeeze the sides of the connector, since the connector is locked in place.

Notes on playing a Super Audio CD on a Super Audio CD player

- No sound is output when playing a Super Audio CD on a Super Audio CD player connected to only the COAXIAL SA-CD/CD IN jack on this receiver. When you play a Super Audio CD, connect the player to the MULTI CHANNEL INPUT or SA-CD/CD IN jacks on this receiver. Refer to the operating instructions supplied with the Super Audio CD player.
- You cannot make digital recordings of a Super Audio CD.

If you want to connect several digital components, but cannot find an unused input

See “Enjoying the sound/images from other inputs” (page 102).

Connecting components with multi channel output jacks

If your DVD player, Blu-ray disc player or Super Audio CD player is equipped with multi channel output jacks, you can connect them to the MULTI CHANNEL INPUT jacks of this receiver to enjoy multi channel sound. Alternatively, the multi channel input jacks can be used to connect an external multi channel decoder.

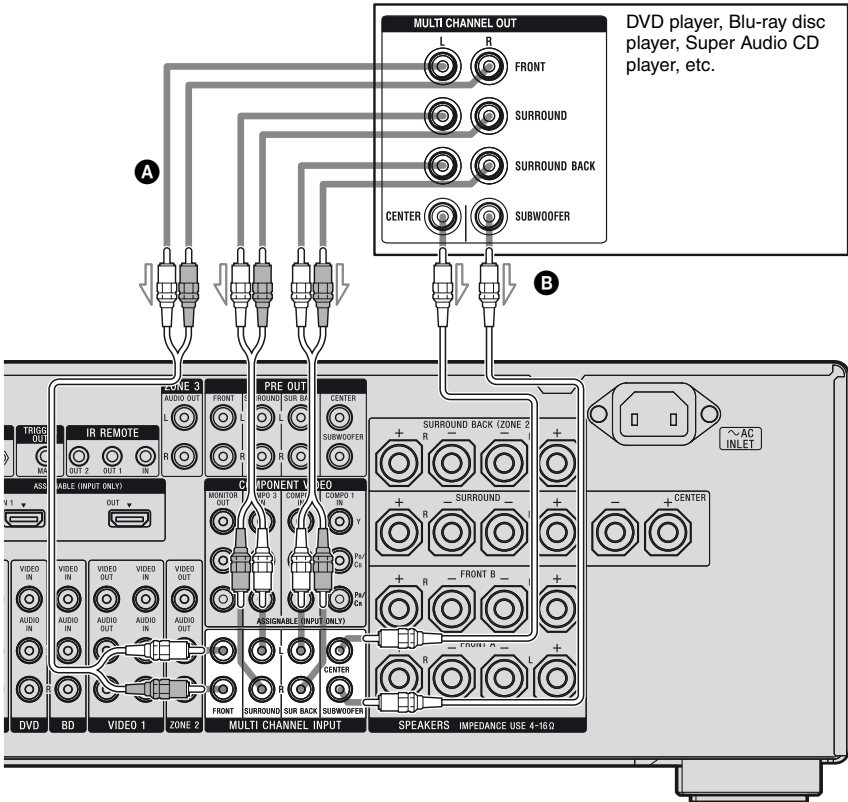

DVD player, Blu-ray disc player, Super Audio CD player, etc.

- A** Audio cord (not supplied)
- B** Monaural audio cord (not supplied)

Notes

- DVD player, Blu-ray disc player and Super Audio CD player may not have the SURROUND BACK jacks.

- When "Sur Back Assign" is set to "BI-AMP" or "ZONE2" in the Speaker settings menu, the input to the SUR BACK jacks is invalid.
- Audio signals input from the MULTI CHANNEL INPUT jacks are not output to other audio output jacks. The signals cannot be recorded.

Connecting components with analog audio jacks

The following illustration shows how to connect a component with analog jacks, such as a tape deck, turntable, etc.

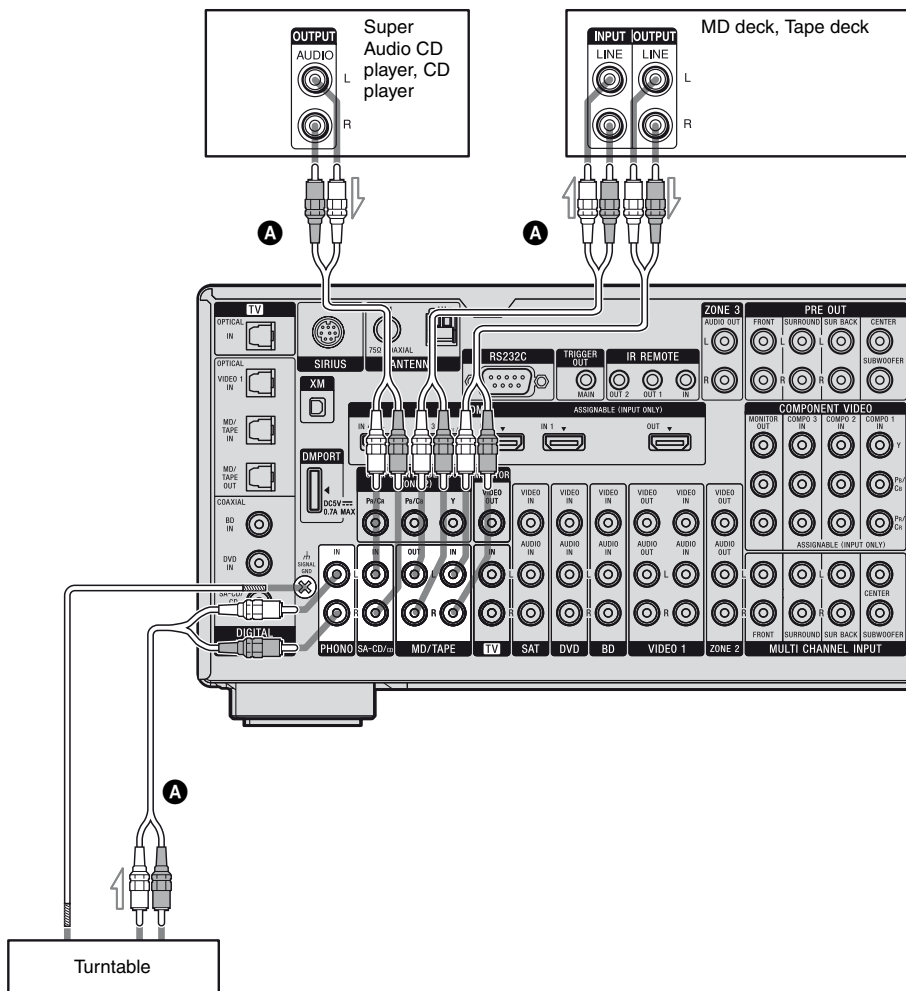

A Audio cord (not supplied)

Note

If your turntable has a ground (earth) wire, connect it to the (♁) SIGNAL GND terminal.

4b: Connecting the video components

How to hook up your components

This section describes how to hook up your components to this receiver. Before you begin, see “Component to be connected” below for the pages which describe how to connect each component.

Before connecting cords, be sure to disconnect the AC power cord (mains lead).

After hooking up all your components, proceed to “5: Connecting the antennas (aerials)” (page 36).

Component to be connected	Page
TV	19
With HDMI jack	26
DVD player	29
Blu-ray disc player	30
Satellite tuner, Set-top box	31
DVD recorder, VCR	32
Camcorder, video game, etc.	32

If you want to connect several digital components, but cannot find an unused input

See “Enjoying the sound/images from other inputs” (page 102).

Notes

- When connecting optical digital cords, insert the plugs straight in until they click into place.
- Do not bend or tie optical digital cord.

Tip

All the digital audio jacks are compatible with 32 kHz, 44.1 kHz, 48 kHz and 96 kHz sampling frequencies.

Video input/output jacks to be connected

The image quality depends on the connecting jack. See the illustration that follows. Select the connection according to the jacks on your components.

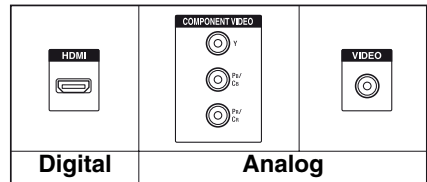



High quality image

Note

Be sure to turn on the receiver when the video and audio signals of a playback component are being output to a TV via the receiver. Unless the power is turned on, neither video nor audio signals will be transmitted.

Connecting components with HDMI jacks

HDMI is the abbreviated name for High-Definition Multimedia Interface. It is an interface which transmits video and audio signals in digital format.

HDMI features

- A digital audio signals transmitted by HDMI can be output from the speakers and the PRE OUT jacks on this receiver. This signal supports Dolby Digital, DTS, and Linear PCM.
- Linear PCM (sampling frequency less than 192 kHz) with digital audio signals of up to 8 channels can be received with this receiver using the HDMI IN jack.
- Analog video signals input to the VIDEO jack or COMPONENT VIDEO jacks can be up-converted as HDMI signals. Audio signals are not output from an HDMI OUT jack when the image is converted.
- This receiver supports High Bitrate Audio (DTS-HD Master Audio, Dolby TrueHD), Deep Color and x.v.Color (x.v.Colour) transmission, extended by HDMI ver1.3.
- This receiver supports the Control for HDMI function. For details, see ““BRAVIA” Sync features” (page 84).
- HDMI 3 input has a better sound quality. When you need a higher sound quality, connect your component to the HDMI IN 3 (for AUDIO) jack and select HDMI 3 as input.

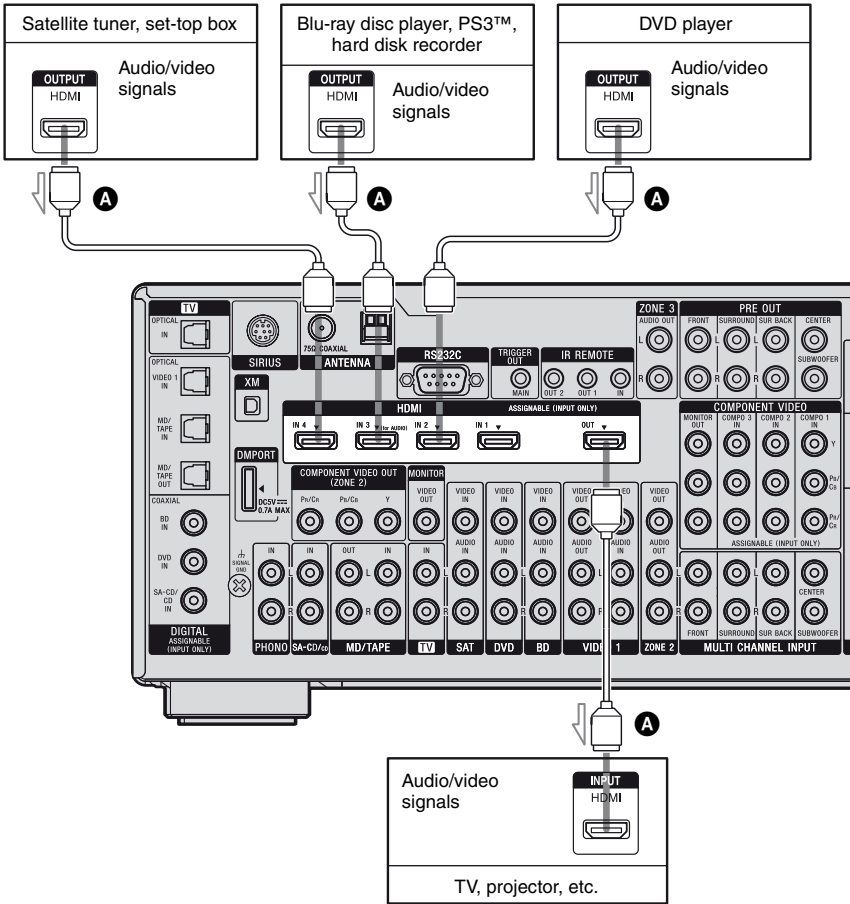

A HDMI cable (not supplied)

Notes on connecting cables

- Use a High Speed HDMI cable. If you use a Standard HDMI cable, 1080p or Deep Color (Deep Colour) images may not be displayed properly.
- Sony recommends that you use an HDMI-authorized cable or Sony HDMI cable.
- We do not recommend using an HDMI-DVI conversion cable. When you connect an HDMI-DVI conversion cable to a DVI-D component, the sound and/or the image may not be output. Connect other audio cords or digital connecting cords, then set “Input Assign” in the Input menu when the sound is not output correctly.

Notes on HDMI connections

- An audio signal input to the HDMI IN jack is output from the speaker output jacks, HDMI OUT jack and PRE OUT jacks. It is not output from any other audio jacks.
- A video signal input to the HDMI IN jack can only be output from the HDMI OUT jack. The video input cannot be output from the VIDEO OUT jacks or MONITOR OUT jacks.
- The audio and video signals of HDMI input are not output from the HDMI OUT jack while the receiver menu is displayed.
- When you want to listen to the sound from the TV speaker, set “Audio Out” to “TV+AMP” in the HDMI settings menu. If set to “AMP”, the sound is not output from the TV speaker.
- DSD signals of Super Audio CD are not input and output.
- Audio signals (sampling frequency, bit length, etc.) transmitted from an HDMI jack may be suppressed by the connected component. Check the setup of the connected component if an image is poor or the sound does not come out of a component connected via the HDMI cable.

- Sound may be interrupted when the sampling frequency, the number of channels or the audio format of audio output signals from the playback component is switched.
- When the connected component is not compatible with copyright protection technology (HDCP), the image and/or the sound from the HDMI OUT jack may be distorted or may not be output. In this case, check the specification of the connected component.
- You can enjoy High Bitrate Audio (DTS-HD Master Audio, Dolby TrueHD), multi channel Linear PCM only with an HDMI connection.
- Set the image resolution of the playback component to more than 720p/1080i to enjoy High Bitrate Audio (DTS-HD Master Audio, Dolby TrueHD).
- The image resolution of the playback component may need certain settings be made before you can enjoy multi channel Linear PCM. Refer to the operating instructions of the playback component.
- Not every HDMI component supports all functions that are defined by the specified HDMI version. For example, components that support HDMI version 1.3a, may not support Deep Color (Deep Colour).
- Refer to the operating instructions of each connected component for details.

Connecting a DVD player

The following illustration shows how to connect a DVD player.

It is not necessary to connect all the cords. Connect the audio and video cords according to the jacks of your components.

Note

To output multi channel digital audio from the DVD player, set the digital audio output setting on the DVD player. Refer to the operating instructions supplied with the DVD player.

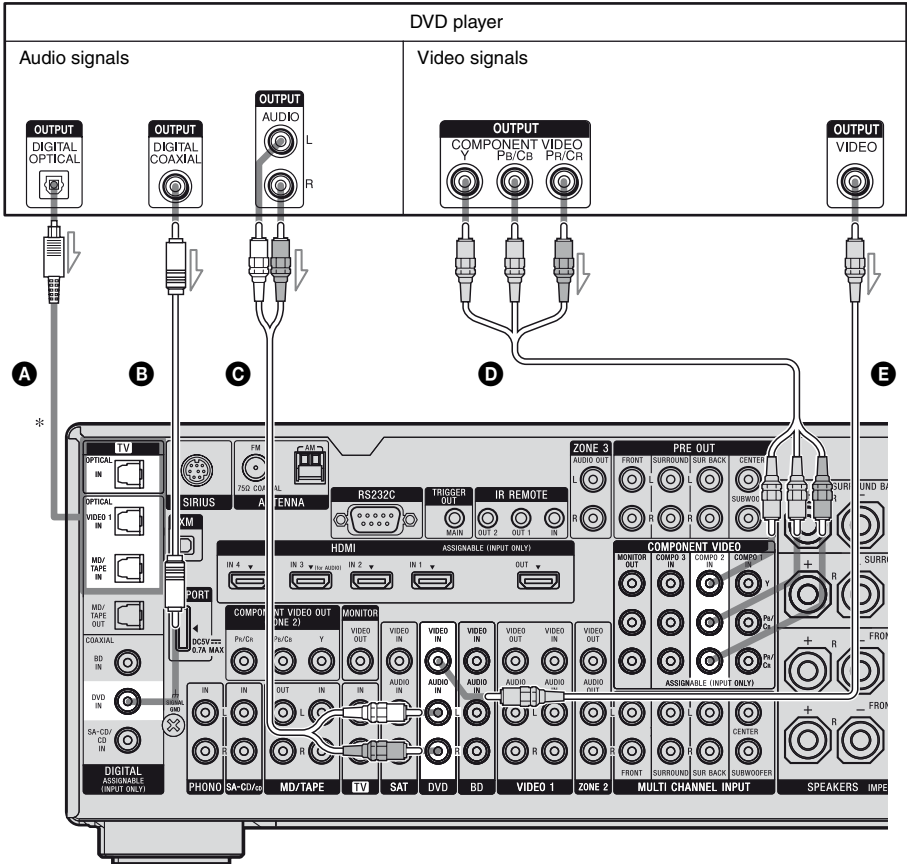

- A** Optical digital cord (not supplied)
- B** Coaxial digital cord (not supplied)
- C** Audio cord (not supplied)
- D** Component video cord (not supplied)
- E** Video cord (not supplied)

* When you connect a component equipped with an OPTICAL jack, set "Input Assign" in the Input menu.

Tip

The COMPONENT VIDEO COMPO 2 IN jacks have been assigned to the DVD player. If you connect your DVD player to the COMPONENT VIDEO COMPO 1 or COMPO 3 IN jacks, set "Input Assign" in the Input menu.

Connecting a Blu-ray disc player

The following illustration shows how to connect a Blu-ray disc player. It is not necessary to connect all the cords. Connect the audio and video cords according to the jacks of your components.

Note

To output multi channel digital audio from the Blu-ray disc player, set the digital audio output setting on the Blu-ray disc player. Refer to the operating instructions supplied with the Blu-ray disc player.

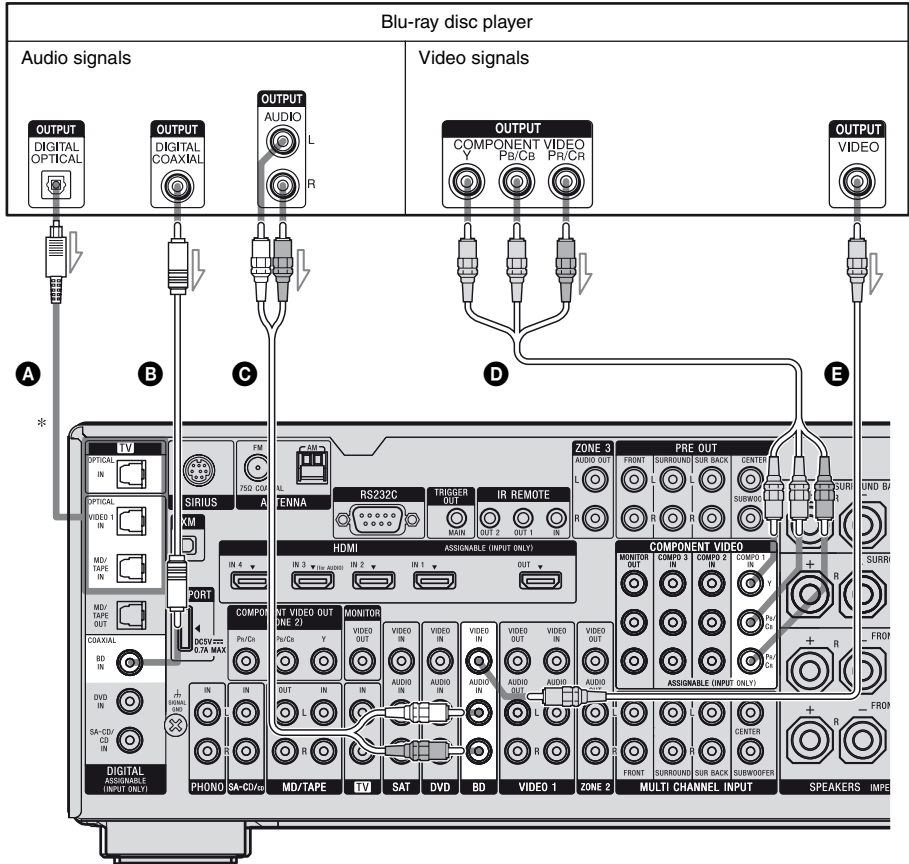

- A** Optical digital cord (not supplied)
- B** Coaxial digital cord (not supplied)
- C** Audio cord (not supplied)
- D** Component video cord (not supplied)
- E** Video cord (not supplied)

* When you connect a component equipped with an OPTICAL jack, set "Input Assign" in the Input menu.

Tip

The COMPONENT VIDEO COMPO 1 IN jacks have been assigned to the Blu-ray disc player. If you connect your Blu-ray disc player to the COMPONENT VIDEO COMPO 2 or COMPO 3 IN jacks, set "Input Assign" in the Input menu.

Connecting a satellite tuner, set-top box

The following illustration shows how to connect a satellite tuner or set-top box. It is not necessary to connect all the cords. Connect the audio and video cords according to the jacks of your components.

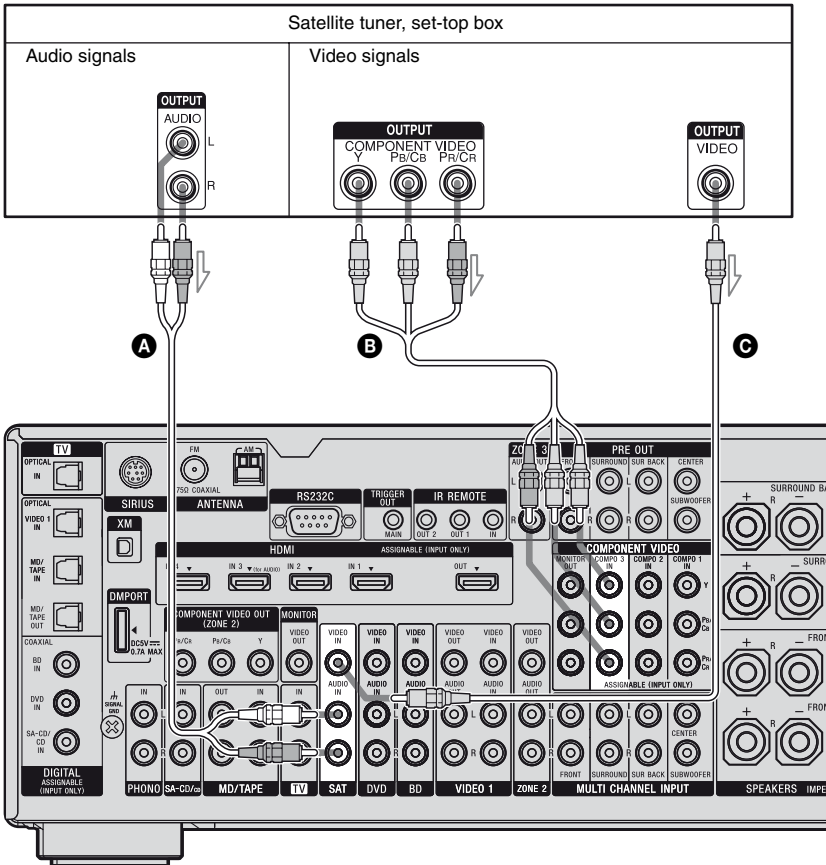

- A** Audio cord (not supplied)
- B** Component video cord (not supplied)
- C** Video cord (not supplied)

Tip

The COMPONENT VIDEO COMPO 3 IN jacks have been assigned to the satellite tuner or set-top box. If you connect your satellite tuner or set-top box to the COMPONENT VIDEO COMPO 1 or COMPO 2 IN jacks, set "Input Assign" in the Input menu.

Connecting components with analog video and audio jack

It is not necessary to connect all the cords. Connect the audio and video cords according to the jacks of your components.

The following illustration shows how to connect a component which has analog jacks such as a DVD recorder, VCR, etc.

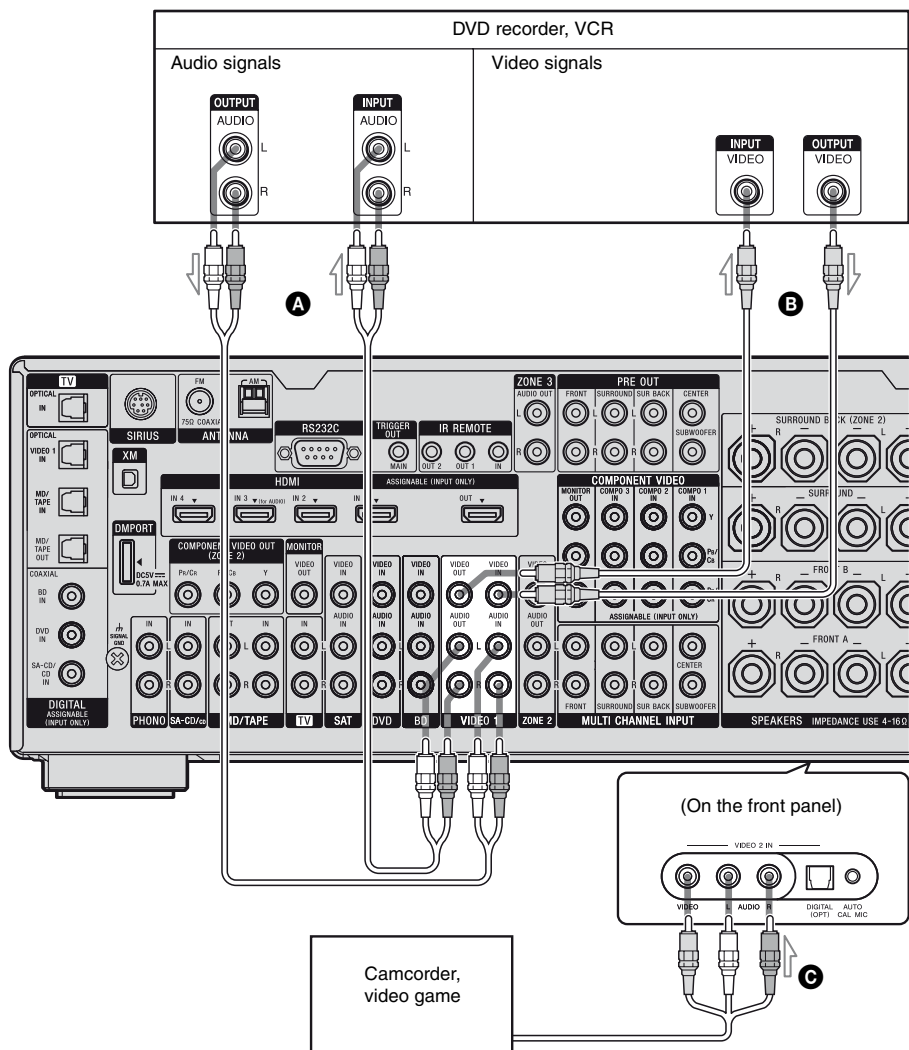

- A** Audio cord (not supplied)
- B** Video cord (not supplied)
- C** Audio/video cord (not supplied)

Function for conversion of video signals

This receiver is equipped with a function for converting video signals. You can output the video signal after connecting this receiver via the MONITOR OUT or HDMI OUT jack as shown in the illustration.

- Video signals can be up-converted as HDMI video and component video signals.
- Component video signals can be output as HDMI video and video signals.

For details on the video converting function, see “In the video input/output conversion table classified by the menu settings” (page 35).

In the video input/output conversion table of the receiver

Output Signals

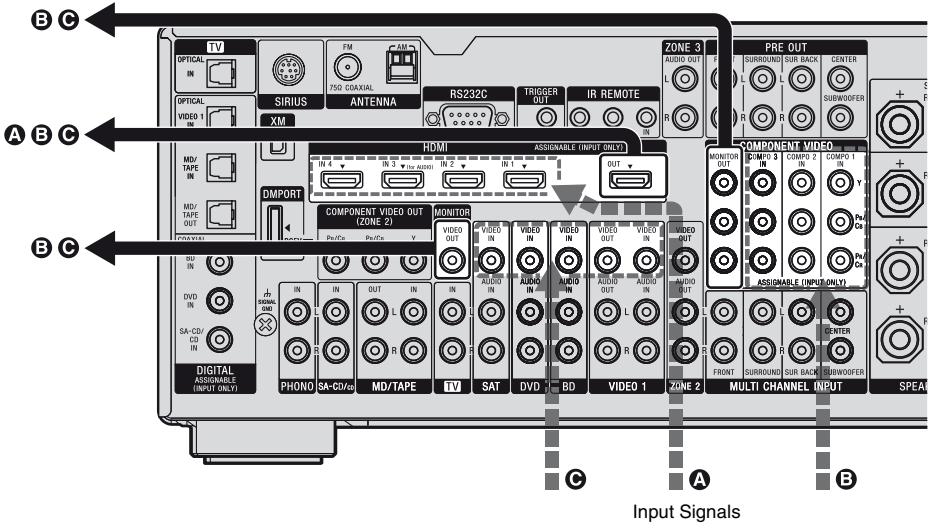

Input Signals

INPUT jack \ OUTPUT jack	HDMI OUT	COMPONENT VIDEO MONITOR OUT	MONITOR VIDEO OUT
HDMI IN 1/2/3/4 A	△	X	X
COMPONENT VIDEO IN B	○	○/△	○
VIDEO IN C	○	○	○/△*

○ : Video signals are converted and output through the video converter.

△ : The same type of signal as that of the input signal is output. Video signals are not converted.

X : Video signals are not output.

* Video signals are output when “Resolution” is set to “DIRECT” in the Video settings menu.

Notes on converting video signals

- When video signals from a VCR, etc., are converted on this receiver and then output to your TV, depending on the status of the video signal output, the image on the TV screen may appear distorted horizontally or no image may be output.
- HDMI video signals cannot be converted to component video signals and video signals.
- The converted video signals are output only from the MONITOR OUT jacks. They are not output from the VIDEO OUT jacks or the ZONE 2 VIDEO OUT jack.
- When you play a VCR with an image improvement circuit, such as Time Base Corrector (TBC), the images may be distorted or may not be output. In this case, set the image improvement circuit function to off.
- The resolution of the signals output to the COMPONENT VIDEO MONITOR OUT jacks is converted up to 1080i. The resolution of the signals output to the HDMI OUT jack is converted up to 1080p.
- COMPONENT VIDEO MONITOR OUT jacks have restrictions on resolution when the resolution of video signals protected by copyright technology is converted. Resolution of up to 480p can be output to the COMPONENT VIDEO MONITOR OUT jacks. The HDMI OUT jack has no restriction on resolution.
- Video signals for which the resolution has been converted can be output from either the COMPONENT VIDEO MONITOR OUT jacks or the HDMI OUT jack. The video signals are output from the HDMI OUT jack when both are connected.
- Set “Resolution” to “AUTO” or “480i/576i” in the Video settings menu to output the video signals from the MONITOR VIDEO OUT or COMPONENT VIDEO MONITOR OUT jack when both are connected.

To display Closed Caption

Set “Resolution” to “DIRECT” in the Video settings menu when receiving a signal that supports Closed Captions. Use the same kind of cords for the input/output signals.

To connect a recording component

When recording, connect the recording component to the VIDEO OUT jacks of the receiver. Connect cords for input and output signals to the same type of jack, as VIDEO OUT jacks do not have an up-conversion function.

Note

Signals output from the HDMI OUT or MONITOR OUT jacks may not be recorded properly.

In the video input/output conversion table classified by the menu settings

For details on “Resolution” menu setting, see “Settings for the video (Video settings menu)” (page 57) and on operating, see “Converting analog video input signals” (page 96).

“Resolution” menu setting	Output from	HDMI OUT jack	COMPONENT VIDEO MONITOR OUT jacks	MONITOR VIDEO OUT jack
	Input signals			
DIRECT	Component video	X	△	X
	Video	X	X	△
AUTO (initial setting)	Component video	○ ^{a)}	○ ^{b)}	○ ^{b)}
	Video	○ ^{a)}	○ ^{b)}	○ ^{b)}
480i/576i	Component video	○ ^{c)}	○	○
	Video	○ ^{c)}	○	○
480p/576p	Component video	○	○	X
	Video	○	○	△
720p, 1080i	Component video	○	○ ^{d)}	X
	Video	○	○ ^{d)}	△
1080p	Component video	○	△	X
	Video	○	X	△

○ : Video signals are converted and output through the video converter.

△ : The same type of signal as that of the input signal is output. Video signals are not converted.

X : Video signals are not output.

^{a)}The resolution is set automatically, depending on the connected TV.

^{b)}When the TV is connected to jacks other than the HDMI jacks, 480i/576i signals are output when “Resolution” is set to “AUTO”.

^{c)}480p/576p signals are output even if 480i/576i is set.

^{d)}Video signals without copyright protection are output based on the settings menu. Video signals with copyright protection are output as 480p.

Notes

- Video signals are not output from the COMPONENT VIDEO MONITOR OUT or MONITOR VIDEO OUT jacks when the TV, etc., is connected to the HDMI OUT jack.
- If you select a resolution that the connected TV does not support in the “Resolution” menu, the images from the TV cannot be output correctly.
- Converted HDMI image output signals do not support “x.v.Color (x.v.Colour)” and Deep Color (Deep Colour).

5: Connecting the antennas (aerials)

Connect the supplied AM loop antenna (aerial) and FM wire antenna (aerial).
Before connecting the antennas (aerials), be sure to disconnect the AC power cord (mains lead).

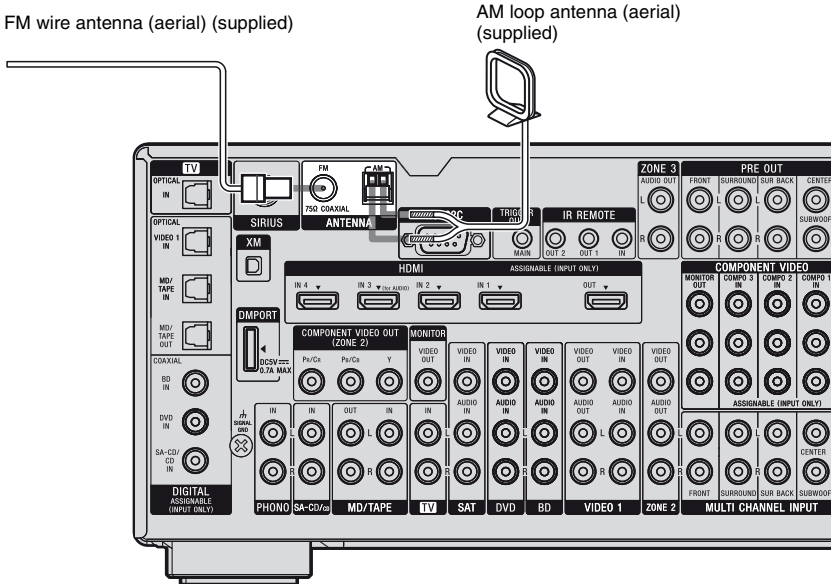

Notes

- To prevent noise pickup, keep the AM loop antenna (aerial) away from the receiver and other components.
- Be sure to fully extend the FM wire antenna (aerial).
- After connecting the FM wire antenna (aerial), keep it as horizontal as possible.

6: Preparing the receiver and the remote

Connecting the AC power cord (mains lead)

Connect the supplied AC power cord (mains lead) to the AC INLET terminal on the receiver, then connect the AC power cord (mains lead) to a wall outlet (mains).

Notes

- Before connecting the AC power cord (mains lead), make sure that metallic wires of the speaker cords are not touching each other between the SPEAKERS terminals.
- Connect the AC power cord (mains lead) firmly.

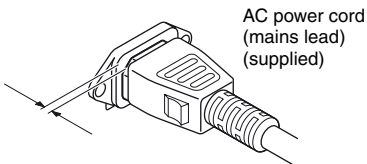
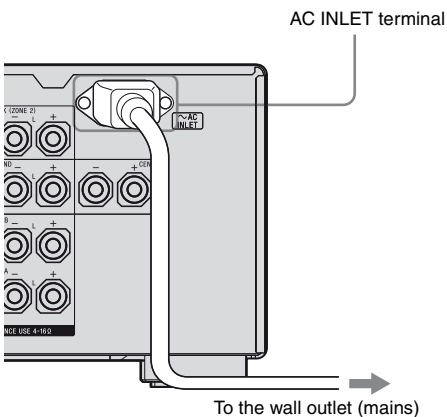

A several space is left between the plug and the rear panel even when the power cord (mains lead) is inserted firmly. The cord is supposed be connected this way. This is not malfunction.

Performing initial setup operations

Before using the receiver for the first time, initialize the receiver by performing the following procedure. This procedure can also be used to return settings you have made to their factory defaults.

Be sure to use the buttons on the receiver for this operation.

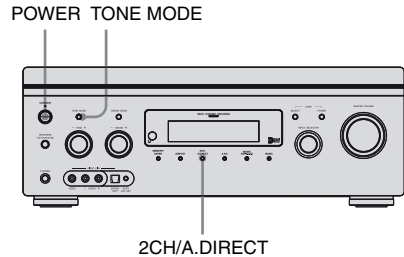

- 1 Press POWER to turn off the receiver.**
- 2 While holding down TONE MODE and 2CH/A.DIRECT, press POWER to turn on the receiver.**
- 3 Release the TONE MODE and 2CH/A.DIRECT after a few seconds.**

After “CLEARING” appears on the display window for a while, “CLEARED !” appears. All the settings you have changed or adjusted are reset to the initial settings.

Inserting batteries into the remote

Insert two R6 (size-AA) batteries in the RM-AAL026 Remote Commander.

Insert two R6 (size-AA) batteries in the RM-AAU039 Remote Commander.

Observe the correct polarity when installing batteries.

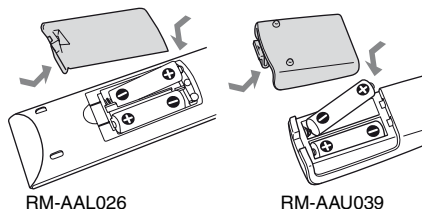

Notes

- Do not leave the remote in an extremely hot or humid place.
- Do not use a new battery with old ones.
- Do not mix manganese batteries and other kinds of batteries.
- Do not expose the remote sensor to direct sunlight or lighting apparatuses. Doing so may cause a malfunction.
- If you do not intend to use the remote for an extended period of time, remove the batteries to avoid possible damage from battery leakage and corrosion.
- When you replace the batteries, the programmed remote codes may be cleared. If this happens, program the remote codes again (page 124).
- When the remote no longer operates the receiver, replace all the batteries with new ones.

About the command mode

The receiver and the remote use the same command mode.

If the command modes of the receiver and the remote are different, you cannot use the remote to operate the receiver.

If the command modes of both the receiver and the remote are those of the initial setting (AV SYSTEM 2), it is not necessary to reset them. You can switch the command mode (AV SYSTEM 1 or AV SYSTEM 2) of the receiver and the remote. If both the receiver and the other Sony component respond to the same remote command, switch the command mode of either the component or the receiver to another command mode so that the component does not respond to the same remote command as the receiver.

To switch the command mode of the receiver

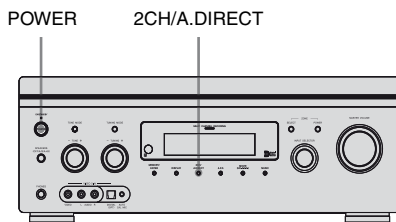

While holding down the 2CH/A.DIRECT, press POWER to turn on the receiver.

When the command mode is set to “AV2”, “C. MODE AV2” appears on the display window.

When the command mode is set to “AV1”, “C. MODE AV1” appears on the display window.

To switch the command mode of the multi function remote commander

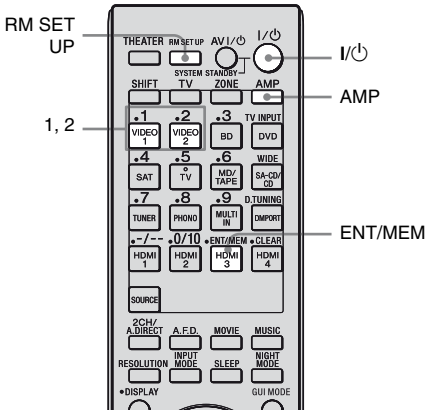

- 1 While holding down RM SET UP, press I/O.
The AMP and ZONE buttons flash.
- 2 Press AMP.
The ZONE button lights off, the AMP button keeps flashing and the SHIFT button lights up.
- 3 Press 1 or 2 while the AMP buttons is flashing.
When you press 1, the command mode is set to AV SYSTEM 1. When you press 2, the command mode is set to AV SYSTEM 2.
The AMP button lights up.
- 4 Press ENT/MEM before the AMP button lights off.
The AMP button flashes twice, then the command mode setting process is completed.

To switch the command mode of the simple remote commander

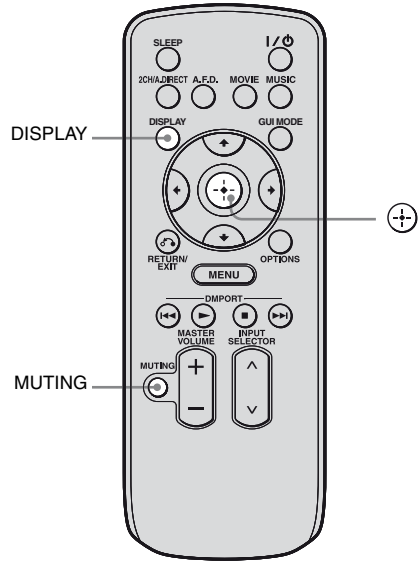

Press and hold DISPLAY, then press MUTING and \oplus at the same time.

7: Operating the receiver using the GUI (Graphical User Interface)

You can change the display mode of the menu to screen mode using the following procedures.

By using the GUI menu, you can make various settings and adjustments.

See “Operating without connecting to the TV” (page 111) if you are not going to use a GUI menu.

Displaying the GUI menu on the TV screen

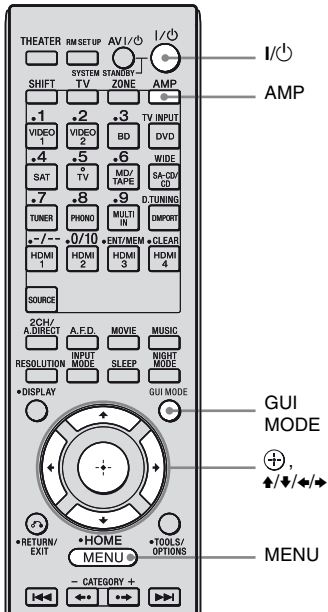

1 Connect a TV to this receiver.
See “3: Connecting the TV” (page 19).

2 Turn on the receiver and the TV.

3 Press AMP to enable receiver operation.

4 Press GUI MODE repeatedly to select “GUI ON”.

The GUI menu appears on the TV screen. Press MENU if the GUI menu does not appear on the TV screen.

5 Press \uparrow/\downarrow repeatedly to select a menu you want, then press \oplus or \rightarrow .

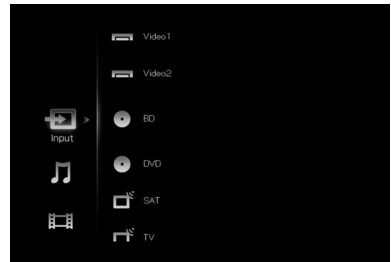

Overview of the menus

The following menu items are available in each settings menu.

Input

Selects the input to the receiver. For details on each input, see “Selecting a component” (page 50).

Music

You can listen to the music from an audio component connected to the DIGITAL MEDIA PORT adapter.

For details on the Music function, see “Enjoying the sound/images from the components connected to the DIGITAL MEDIA PORT” (page 97).

Video

Select the images from the video component connected to the DIGITAL MEDIA PORT adapter (page 97).

FM/AM/XM/SIRIUS

You can listen to the radio using the receiver. For details on the Tuner operation, see “Tuner Operations” (page 71).

Settings

You can use the Settings menu to set and adjust this receiver.



Auto Calibration

You can use the Auto Calibration settings menu to adjust the speakers automatically. For details, see “9: Calibrating the appropriate speaker settings automatically (Auto Calibration)” (page 44).



Speaker

You can use the Speaker settings menu to adjust the speakers manually for the current position, and to set the speaker impedance. For details, see “Setting the speaker impedances” (page 43) and “Adjusting the speaker settings manually” (page 65).



Surround

You can use the Surround settings menu to select the sound field you want for your listening pleasure. For details on adjusting the parameters, see “Enjoying a pre-programmed sound field” (page 59).



EQ

You can use the EQ settings menu to adjust the equalizer. For details, see “Adjusting the equalizer” (page 70).



Multi Zone

You can use the Multi Zone settings menu to operate components in the multi zone. For details on adjusting the parameters, see “Using Multi-zone Features” (page 90).



Audio

For details on adjusting the audio using the Audio settings menu, see “Settings for the audio (Audio settings menu)” (page 56).



Video

For details on adjusting the video using the Video settings menu, see “Settings for the video (Video settings menu)” (page 57).



HDMI

You can use the HDMI settings menu to operate components connected to the HDMI jacks. For details on adjusting the parameters, see “Settings for HDMI (HDMI settings menu)” (page 57).



System

For details on adjusting the system using the System settings menu, see “Settings for the system (System settings menu)” (page 58).

Navigating through menus using the GUI

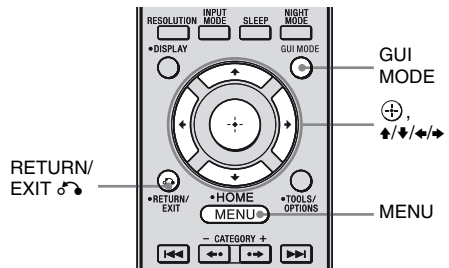

1 Press GUI MODE repeatedly to select “GUI ON”.

The GUI menu appears on the TV screen. Press MENU if the GUI menu does not appear on the TV screen.

- 2** Press \uparrow/\downarrow repeatedly to select a menu you want.



- 3** Press \oplus or \rightarrow to enter the menu.

The menu item list appears on the TV screen.

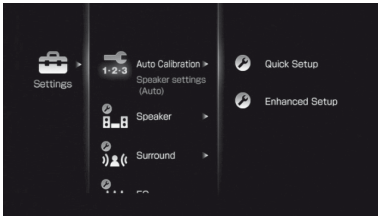

- 4** Press \uparrow/\downarrow repeatedly to select the menu item you want to adjust.

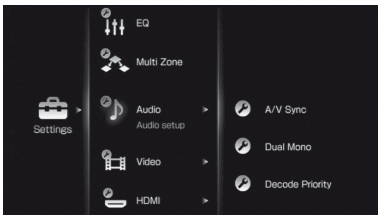

- 5** Press \oplus or \rightarrow to enter the menu item.

- 6** Press \uparrow/\downarrow repeatedly to select the parameter you want.

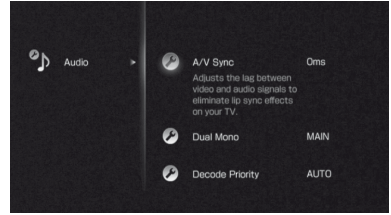

- 7** Press \oplus to enter the parameter.

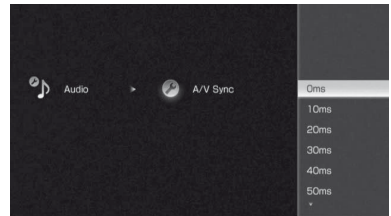

- 8** Press \uparrow/\downarrow repeatedly to select the settings you want.

- 9** Press \oplus to enter the setting.

To return to the previous screen

Press \leftarrow or RETURN/EXIT \rightarrow .

To exit the menu

Press MENU.

To exit "GUI MODE"

Press GUI MODE repeatedly to select "GUI OFF".

8: Setting the speakers

Setting the speaker impedances

Set the appropriate speaker impedance for the speakers you are using.

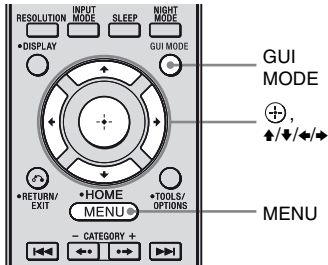

- 1 Press **GUI MODE** repeatedly to select “GUI ON”.

The GUI menu appears on the TV screen. Press **MENU** if the GUI menu does not appear on the TV screen.

- 2 Press **↑/↓** repeatedly to select “Settings”, then press **⊕** or **➔**.

The Settings menu list appears on the TV screen.

- 3 Press **↑/↓** repeatedly to select “Speaker”, then press **⊕** or **➔**.

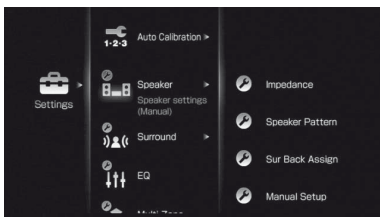

- 4 Press **↑/↓** repeatedly to select “Impedance”, then press **⊕**.

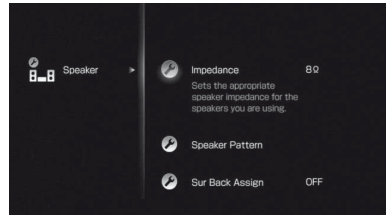

- 5 Press **↑/↓** repeatedly to select “4 Ω” or “8 Ω” depending on the speakers you are using, then press **⊕**.

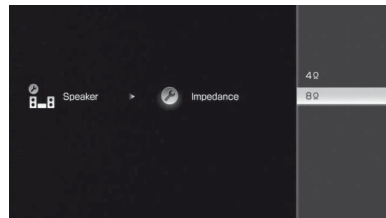

Notes

- If you are not sure of the impedances of the speakers, refer to the operating instructions supplied with your speakers. (This information is often found on the back of the speaker.)
- When you connect all speakers with a normal impedance of 8 ohms or higher, set “Impedance” to “8 Ω”. When connecting other types of speakers, set it to “4 Ω”.
- When you connect front speakers to both the SPEAKERS A and B terminals, connect the speakers with a normal impedance of 8 ohms or higher.
 - When you connect speakers with impedance of 16 ohms or higher in both “A” and “B” configuration:
Set “Impedance” to “8 Ω” in the Speaker settings menu.
 - For other types of speakers in other configurations:
Set “Impedance” to “4 Ω” in the Speaker settings menu.

Selecting the front speakers

You can select the front speakers you want to drive.

SPEAKERS (OFF/A/B/A+B)

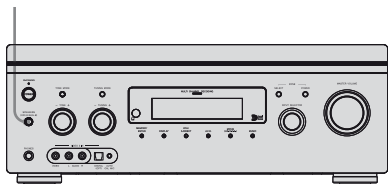

Press SPEAKERS (OFF/A/B/A+B) repeatedly to select the front speaker system you want to drive.

Note

This setting is not available when headphones are connected.

To select	Light up
The speakers connected to the FRONT SPEAKERS A terminals.	SP A
The speakers connected to the FRONT SPEAKERS B terminals.	SP B
The speakers connected to both the FRONT SPEAKERS A and B terminals (parallel connection).	SP A+B

To turn off the speaker output

Press SPEAKERS (OFF/A/B/A+B) repeatedly until the “SP A”, “SP B” and “SP A+B” indicators on the display window lights off.

“ALL OFF” appears in the display window.

9: Calibrating the appropriate speaker settings automatically (Auto Calibration)

The DCAC (Digital Cinema Auto Calibration) function allows you to perform automatic calibration as follows:

- Check the connection between each speaker and the receiver.^{a)}
- Measure the polarity of speakers.
- Measure the distance of each speaker from your seating position automatically.^{a)}
- Measure the speaker size.^{a)}
- Adjust the speaker level.
- Measure the frequency characteristics.^{a)b)}

^{a)} The measurement result is not utilized in the following cases.

- The multi channel input is selected.
- “2ch Analog Direct” is being used.

^{b)} The measurement is not utilized in the following cases.

- Dolby TrueHD signals with a sampling frequency of 176.4 kHz and higher are being received.
- PCM signals with a sampling frequency of 176.4 kHz and higher are being received.

The DCAC is designed to obtain proper sound balance in your room. However, you can adjust the speaker levels and balance manually according to your preference. For details, see “Making settings with the Test Tone menu” (page 68).

Before you perform the Auto Calibration

Before you perform the Auto Calibration, set up and connect the speakers (page 15-18).

- The AUTO CAL MIC jack is used for the supplied optimizer microphone only. Do not connect other microphones. Doing so may damage the receiver and the microphone.
- During the measurement, the sound that comes out of the speakers is very loud. The volume of the sound cannot be adjusted. Pay attention to the presence of children or to the effect on your neighborhood.
- Perform the measurement in a quiet environment to avoid the effect of noise and get a more accurate measurement.
- If there are any obstacles in the path between the optimizer microphone and the speakers, the calibration cannot be performed correctly. Remove any obstacle from the measurement area to avoid measurement error.
- When you use a bi-amplifier connection, set “Sur Back Assign” to “BI-AMP” in the Speaker settings menu before you perform Auto Calibration.

Notes

- The Auto Calibration function does not work if
 - headphones are connected.
 - SPEAKERS (OFF/A/B/A+B) is set to off.
- If the muting function has been activated before you perform Auto Calibration, the muting function will be set to off automatically.

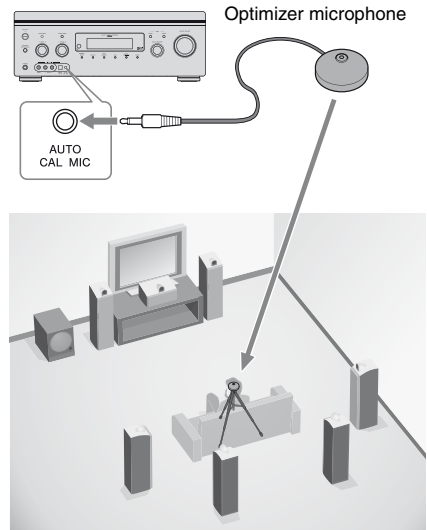

1 Connect the supplied optimizer microphone to the AUTO CAL MIC jack.

2 Set up the optimizer microphone.

Place the optimizer microphone at your seating position. Use a stool or tripod so that the optimizer microphone remains at the same height as your ears.

On setting up the active subwoofer

- When a subwoofer is connected, turn on the subwoofer and turn up the volume beforehand. Turn the MASTER VOLUME knob to just before the mid-point.
- If you connect a subwoofer with the crossover frequency function, set the value to maximum.
- If you connect a subwoofer with an auto standby function, set it to off (deactivated).

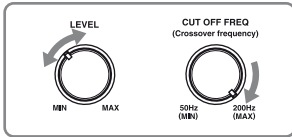

Note

Depending on the characteristics of the subwoofer you are using, the setup distance value may be further away from the actual position.

Using the receiver as a pre-amplifier

You can use the Auto Calibration function when you use the receiver as a pre-amplifier. In this case, the distance value shown on the display may differ from the actual distance value. However, there will be no problems even if you continue to use the receiver with that value.

Performing Auto Calibration

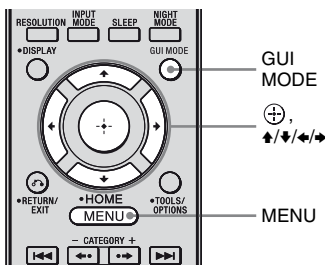

1 Press GUI MODE repeatedly to select “GUI ON”.

The GUI menu appears on the TV screen. Press MENU if the GUI menu does not appear on the TV screen.

2 Press ↑/↓ repeatedly to select “Settings”, then press ⊕ or →.

The Settings menu list appears on the TV screen.

3 Press ↑/↓ repeatedly to select “Auto Calibration”, then press ⊕ or →.

4 Press ↑/↓ repeatedly to select “Quick Setup”, then press ⊕.

5 Press ↑/↓ repeatedly and press ⊕ to un-check the items you do not want to measure.

- Speaker Distance
- Speaker Level
- Frequency Characteristic

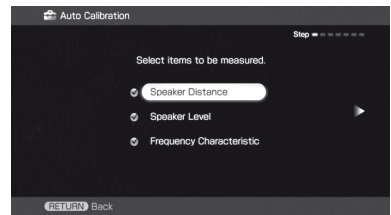

6 Press →.

7 Press ⊕ to select “Start”.

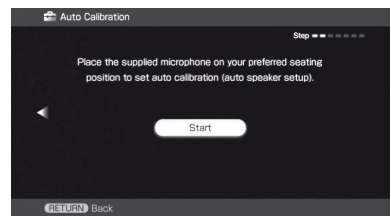

8 The measurement starts in five seconds.

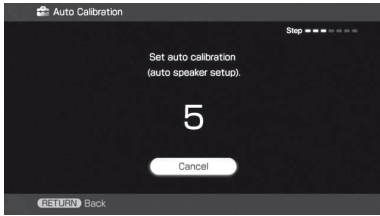

9 Measurement starts.

The measurement process will take approximately 30 seconds with a test tone. Wait until the measurement process completes.

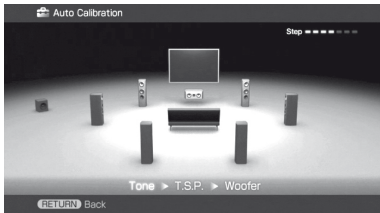

Tips

- Operations other than turning the receiver on or off are deactivated during the measurement.
- In the following situations, the measurements have not been performed correctly or Auto Calibration cannot be performed.
 - when connecting special speakers, such as dipole speakers.
 - when using the zone 2/zone 3 function in zone 2/zone 3.

To cancel the measurement

The measurement will be canceled when you do the following:

- Press I/⏻, input buttons or MUTE.
- Press SPEAKERS (OFF/A/B/A+B) on the receiver.
- Change the volume level.
- Connect the headphones.
- Press GUI MODE.

Confirming/saving the measurement results

1 Confirm the measurement result.

When the measurement ends, a beep sounds and the measurement result appears on the TV screen.

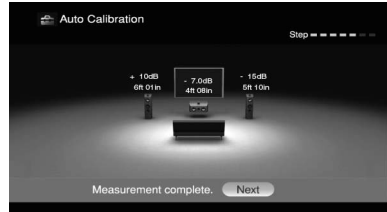

Note

When the speaker(s) is (are) out of the phase, “Out Phase” is displayed on the TV screen. The “+” and “-” terminals of the speaker may be connected the other way around. However, depending on the speakers, “Out Phase” appears on the TV screen even though the speakers are connected properly. This is because of the speakers’ specifications. In this case, you can continue to use the receiver.

Tip

The displayed unit of distance is feet. You can change the unit of distance to meters in “Distance Unit” in the Speaker settings menu.

2 Press (+) to select “Next”.

When “Save auto calibration (auto speaker setup)?” appears on the TV screen, you can select whether to confirm the warning (“Yes”) or not (“No”). Follow the instructions of the TV screen when you select “Yes”.

For details on warning and error codes, see “Message list after Auto Calibration measurement” (page 49).

Tip

Press (+) on the remote when “Please Press ENTER.” appears on the TV screen.

3 Press **←/→** repeatedly to select “Yes”, then press **⊕**.

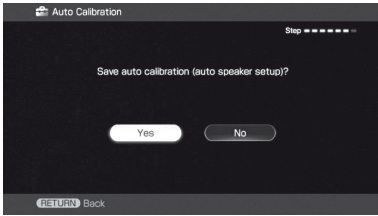

4 Press **↑/↓** repeatedly to select the Auto Calibration type, then press **⊕**.

The measurement results are saved.

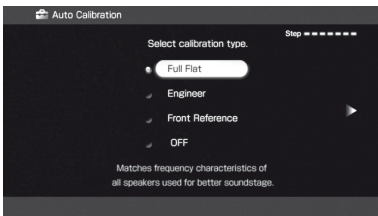

Parameter	Explanation
Full Flat	Makes the measurement of frequency from each speaker flat.
Engineer	Sets the frequency to one that matches that of the Sony listening room standard.
Front Reference	Adjusts the characteristics of all the speakers to match the characteristics of the front speaker.
OFF	Sets the Auto Calibration EQ to off.

5 Press **→**.

The exit screen appears.

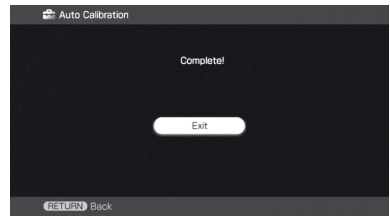

6 Press **⊕** to exit.

Note

The frequency response measurement result is not utilized in the following cases.

- The multi channel input is selected.
- “2ch Analog Direct” is being used.
- Dolby TrueHD signals with a sampling frequency of 176.4 kHz and higher are being received.
- PCM signals with a sampling frequency of 176.4 kHz and higher are being received.

Tip

The size of a speaker (LARGE/SMALL) is determined by the low characteristics. The measurement results may vary, depending on the position of the optimizer microphone and speakers, and the shape of the room. It is recommended that you follow the measurement results. However, you can change those settings in the Speaker settings menu. Save the measurement results first, then try to change the settings if you want.

Message list after Auto Calibration measurement

Message appears in GUI menu [Display window]	Explanation
Error Code: 31 [E-■■■■: 31]*	SPEAKERS (OFF/A/B/A+B) is set to off. Set it to others and perform the measurement again.
Error Code: 32 [E-■■■■: 32]*	None of the speakers were detected. Make sure that the optimizer microphone is connected properly and perform the measurement again. If the optimizer microphone is connected properly but the error code appears, the optimizer microphone cable may be damaged or improperly connected.
Error Code: 33 [E-■■■■: 33]*	<ul style="list-style-type: none"> • None of the front speakers are connected or only one front speaker is connected. • The optimizer microphone is not connected. • Either the left or right surround speakers is not connected. • Surround back speakers are connected even though surround speakers are not connected. Connect the surround speaker(s) to the SURROUND terminals. • The surround back speaker is connected only to the SPEAKERS SURROUND BACK R terminals. When you connect only one surround back speaker, connect it to the SPEAKERS SURROUND BACK L terminals.
Warning Code: 40 [W-■■■■: 40]*	The measurement has completed. However, the noise level is high. You may be able to perform the measurement properly if you try it again, even though the measurement cannot be performed in all environments. Try to perform the measurement in a quiet environment.
Warning Code: 41 [W-■■■■: 41]*	The input from the microphone is too loud. <ul style="list-style-type: none"> • The distance between the speaker and the microphone may be too close with each other. Retry the measurement after setting them further apart from each other.
Warning Code: 42 [W-■■■■: 42]*	<ul style="list-style-type: none"> • The volume may be too loud when you use the receiver as a pre-amplifier.
Warning Code: 43 [W-■■■■: 43]*	The distance and position of a subwoofer cannot be detected. This may be caused by noise. Try to perform the measurement in a quiet environment.
NO WARNING	There is no warning information.

* ■■■ represent a speaker channel.

F	Front
FL	Front Left
FR	Front Right
CNT	Center
SL	Surround Left
SR	Surround Right
SB	Surround Back
SBL	Surround Back Left
SBR	Surround Back Right
SW	Subwoofer

•Error Code: 31, 32, 33

- 1 Press \leftarrow/\rightarrow to select "Retry", then press \oplus .
- 2 Press \oplus to select "Start".
- 3 Follow the instructions from step 7 of "Performing Auto Calibration".

When a warning code appears

If a warning on the measurement result is present, detailed information is displayed.

Press \oplus to return to step 1 of “Confirming/saving the measurement results” (page 47).

Tip

Depending on the position of the subwoofer, the measurement results for polarity may vary. However, there will be no problems even if you continue to use the receiver with that value.

To set Auto Calibration items more precisely (Enhanced Setup)

On the Auto Calibration menu, select “Enhanced Setup”, then press \oplus .

- Seating Position
You can register three patterns as position 1, 2, and 3, depending on the seating position, listening environment, and measurement conditions.
- Calibration Type
For details, see the table on page 48.

Optional menu parameters for Enhanced Setup settings

- EQ Curve
EQ curve measurement is displayed.
- Name Input
You can rename the position number. For details, see “Naming inputs” (page 101).

Playback

Selecting a component

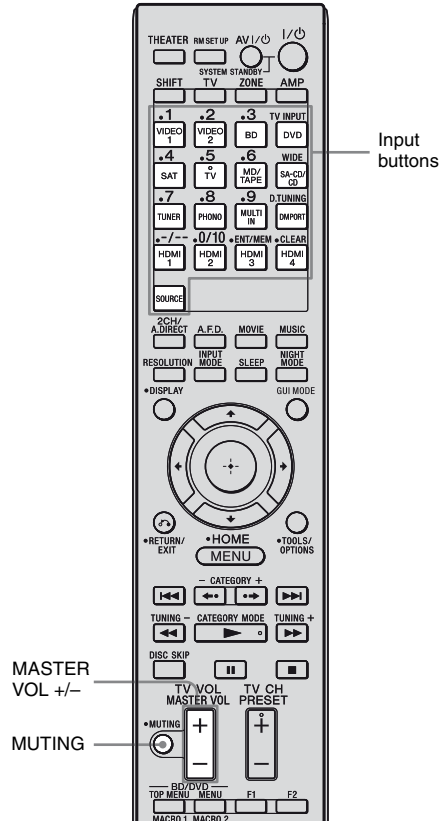

- 1 Press one of the input buttons to select the component you want.

You can also use INPUT SELECTOR on the receiver.

Selected input	Components that can be played back
VIDEO1	VCR, etc., connected to the VIDEO 1 jack.
VIDEO2	Camcorder and video game, etc., connected to the VIDEO 2 IN jack.
BD	Blu-ray disc player, etc., connected to the BD jack.
DVD	DVD player, etc., connected to the DVD jack.
SAT	Satellite tuner, etc., connected to the SAT jack.
TV	TV connected to the TV jack.
MD/TAPE	MD or Tape deck, etc., connected to the MD/TAPE jack.
SA-CD/CD	Super Audio CD or CD player, etc., connected to the SA-CD/CD jack.
TUNER (FM TUNER or AM TUNER)	Built-in radio tuner.
TUNER (XM RADIO or SIRIUS)	XM Mini-Tuner and Home Dock connected to the XM jack or SiriusConnect Home tuner connected to the SIRIUS jack.
PHONO	Turntable, etc., connected to the PHONO jack.
MULTI IN	Component connected to the MULTI CHANNEL INPUT jack.
DMPORT	Portable audio, etc., connected to the DIGITAL MEDIA PORT adapter connected to the receiver.
HDMI1, 2, 3, 4	HDMI components connected to the HDMI IN 1, HDMI IN 2, HDMI IN 3 or HDMI IN 4 jack.

2 Turn on the component and start playback.

3 Press MASTER VOL +/- to adjust the volume.

You can also use MASTER VOLUME on the receiver.

Tips

- You can adjust the volume differently depending on the speed with which you turn the MASTER VOLUME knob.
To turn the volume up or down quickly: turn the knob quickly.
To make fine adjustment: turn the knob slowly.
- You can adjust the volume differently depending on the length of time you press and hold the MASTER VOL +/- button on the remote.
To turn the volume up or down quickly: press and hold the button.
To make fine adjustment: press the button and release it immediately.

To activate the muting function

Press MUTING on the remote. To cancel, press MUTING on the remote again or turn MASTER VOLUME clockwise to raise the volume.

To avoid damaging your speakers

Before you turn off the receiver, be sure to turn down the volume level.

Listening to a Super Audio CD/CD

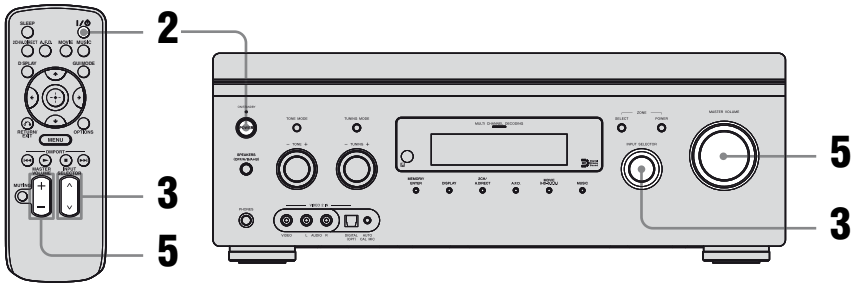

- The operation is described for a Sony Super Audio CD player.
- Refer to the operating instructions supplied with the Super Audio CD player or CD player.



You can select the sound field to suit the music. See page 63 for details.

- 1 Turn on the Super Audio CD player or CD player, then place the disc in the tray.**
- 2 Turn on the receiver.**
- 3 Press INPUT SELECTOR \wedge/\vee to select “SA-CD/CD”.**
You can also use INPUT SELECTOR on this receiver to select “SA-CD/CD”.
- 4 Play back the disc.**
- 5 Adjust to a suitable volume.**
- 6 After you have finished listening to a Super Audio CD or CD, eject the disc and turn off the receiver and the Super Audio CD player or CD player.**

Watching a DVD/Blu-ray Disc

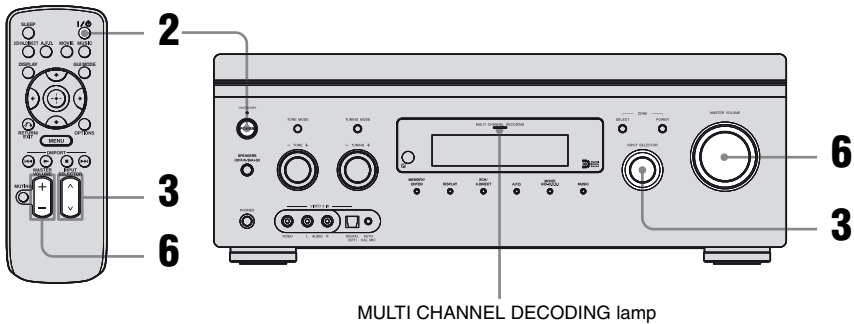

- Refer to the operating instructions supplied with the TV and DVD player or Blu-ray disc player.
- Check the following if you cannot listen to the multi channel sound.
 - Be sure the sound source corresponds to the multi channel format (the MULTI CHANNEL DECODING lamp on the front panel lights up during playback).
 - Be sure this receiver is connected to the DVD player or Blu-ray disc player via a digital connection.
 - Be sure the digital audio output of the DVD player or Blu-ray disc player is set up properly.



- Select the sound format of the disc to be played, if necessary.
- You can select the sound field to suit the movie or the music. See page 63 for details.

- 1** Turn on the TV and DVD player or Blu-ray disc player.
- 2** Turn on the receiver.
- 3** Press INPUT SELECTOR \wedge/V to select “DVD” or “BD”.
You can also use INPUT SELECTOR on this receiver to select “DVD” or “BD”.
- 4** Switch the input of the TV so that an image of the DVD or Blu-ray Disc is displayed.
- 5** Play back the disc.
- 6** Adjust to a suitable volume.
- 7** After you have finished watching a DVD or Blu-ray Disc, eject the disc and turn off the receiver, the TV, and the DVD player or Blu-ray disc player.

Enjoying video games

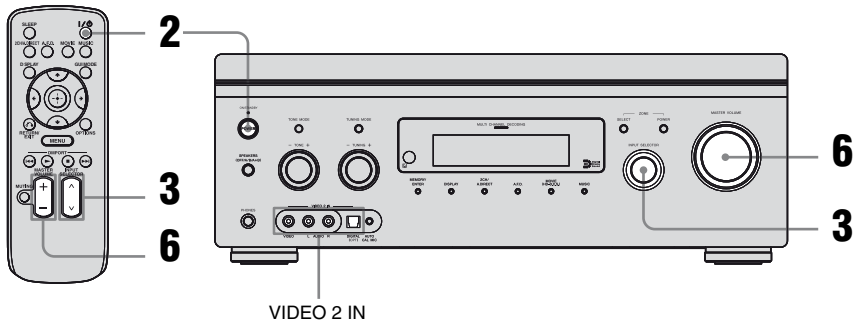

Refer to the operating instructions supplied with the TV and video game.

1 Turn on the TV and video game.

2 Turn on the receiver.

3 Press **INPUT SELECTOR ^/V** to select “**VIDEO 2**”*.

You can also use **INPUT SELECTOR** on this receiver to select “**VIDEO 2**”*.

* When you connect a video game to the **VIDEO 2 IN** jack on the front panel.

4 Switch the input of the TV so that an image of the video game is displayed.

5 Place the disc in the tray and play it back on the video game.

6 Adjust to a suitable volume.

7 After you have finished playing a game, eject the disc and turn off the receiver, the TV, and the video game.

Watching video

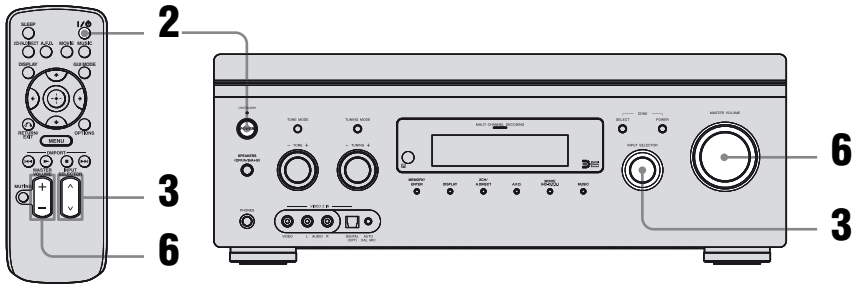

Refer to the operating instructions supplied with the TV and VCR.

- 1** Turn on the VCR.
- 2** Turn on the receiver.
- 3** Press **INPUT SELECTOR** \wedge/\vee to select “VIDEO 1”*.

You can also use **INPUT SELECTOR** on this receiver to select “VIDEO 1”*.

* When you connect VCR to the VIDEO 1 jack.

- 4** Switch the input of the TV so that an image of the VCR is displayed.
- 5** Play back the tape on the VCR.
- 6** Adjust to a suitable volume.
- 7** After you have finished watching a video, eject the tape and turn off the receiver, the TV, and the VCR.

Settings for the audio

(Audio settings menu)

You can use the Audio settings menu to make settings for the audio to suit your preference. Select “Audio” in the Settings menu. For details on adjusting the parameters, see “7: Operating the receiver using the GUI (Graphical User Interface)” (page 40).

Audio settings menu parameters

■ A/V Sync (Audio with video output synchronization)

Lets you delay the output of audio to minimize the time gap between audio output and visual display. You can adjust the delay from 0 ms to 300 ms in 10 ms steps.

Notes

- This function is useful when you use a large LCD or plasma monitor or a projector.
- This function does not work in the following cases.
 - The multi channel input is selected.
 - “2ch Analog Direct” is being used.

■ Dual Mono (Digital broadcast language selection)

Lets you select the language you want to listen to during a digital broadcast. This feature only functions for Dolby Digital sources.

- MAIN/SUB
Sound of the main language will be output through the front left speaker, and sound of the sub language will be output through the front right speaker simultaneously.
- MAIN
Sound of the main language will be output.
- SUB
Sound of the sub language will be output.

■ Decode Priority (Digital audio input decoding priority)

Lets you specify the input mode for the digital signal input to the HDMI IN jacks.

- PCM
When signals from the HDMI IN jack are selected, only PCM signals are output from the connected player. To prevent interruption when playback starts, set to “PCM”. When signals in other format are received, set this item to “AUTO”.
- AUTO
Automatically switches the input mode between Dolby Digital, DTS, or PCM.

Note

Even when “Decode Priority” is set to “PCM”, the sound may be interrupted at the very beginning of the first track depending on the CD being played back.

Settings for the video

(Video settings menu)

You can use the Video settings menu to make settings for video. Select “Video” in the Settings menu. For details on adjusting the parameters, see “7: Operating the receiver using the GUI (Graphical User Interface)” (page 40).

Video settings menu parameters

■ Resolution (Video signals conversion)

Lets you convert the resolution of analog video input signals.

- DIRECT
- AUTO
- 480i/576i
- 480p/576p
- 720p
- 1080i
- 1080p

For details on operation, see “In the video input/output conversion table classified by the menu settings” (page 35).

Settings for HDMI

(HDMI settings menu)

You can use the HDMI settings menu to make the required settings for components connected to the HDMI jack. Select “HDMI” in the Settings menu. For details on adjusting the parameters, see “7: Operating the receiver using the GUI (Graphical User Interface)” (page 40).

HDMI settings menu parameters

■ Control for HDMI (Control for HDMI)

Lets you turn the components connected to the HDMI jack using an HDMI cable on or off.

- OFF
- ON

For details on operation, see “Using “BRAVIA” Sync features” (page 84).

Note

When you set “Control for HDMI” to “ON”, “Audio Out” may be changed automatically.

■ Audio Out (HDMI audio input setting)

Lets you set the audio output for HDMI from the playback component connected to the receiver via an HDMI connection.

- TV+AMP

The sound is output from the TV speaker and the speakers connected to the receiver.

Notes

- The sound quality of the playback component depends on the TV’s sound quality, such as the number of channels, the sampling frequency, etc. When the TV has stereo speakers, the sound output from the receiver is also stereo as that of the TV, even if you play multi channel source.
- When you connect the receiver to a video component (projector, etc.), sound may not be output from the receiver. In this case, select “AMP”.
- When you select the input that you have assigned the HDMI input, sound does not output from the TV.

continued

- AMP

The HDMI audio signals from the playback component is only output to speakers connected to the receiver. The multi channel sound can be played back as it is.

Note

Audio signals are not output from the TV's speakers when "Audio Out" is set to "AMP".

■ **24p Auto Sound Sync (24p Auto Sound Sync)**

Lets you turn the "24p Auto Sound Sync" function on or off. This allows HD-D.C.S. to be selected as the optimum sound field automatically when 24p (24 frames per second) signal are input from a playback component, such as a Blu-ray disc player.

- OFF
- ON

Note

When "Control for HDMI" is set to "ON", the receiver detects the 24p signals via "BRAVIA" Sync. Therefore, if a player that is not compatible with "BRAVIA" Sync sends out 24p signals, the receiver will not switch the sound field to HD-D.C.S. On the other hand, when "Control for HDMI" is set to "OFF", the receiver detects the 24p signals by itself.

■ **Subwoofer Level (Subwoofer level for HDMI)**

Lets you set the level of the subwoofer to 0 dB or +10 dB when PCM signals are input via an HDMI connection. You can set the level for each HDMI input independently.

- 0 dB
- +10 dB
- AUTO

The subwoofer level is automatically set to 0 dB or +10 dB depending on the frequency.

Settings for the system (System settings menu)

You can use the System settings menu to customize the settings of the receiver. Select "System" in the Settings menu. For details on adjusting the parameters, see "7: Operating the receiver using the GUI (Graphical User Interface)" (page 40).

System settings menu parameters

■ **Screen Saver (Screen Saver)**

Lets you activate the screen saver function for the GUI menu on the TV connected to the receiver.

- OFF
 - The screen saver function is disabled.
- ON
 - When there has been no operation attempted for 15 minutes, the screen saver function is activated automatically.

■ **Installer Mode (Installer Mode)**

Lets you select the control mode for maintenance and service.

- OFF
- RS232C

■ **Language (Language)**

Lets you select the language for the GUI menu on the TV connected to the receiver.

- English
- Español
- Français
- Deutsch

Enjoying Surround Sound

Enjoying a pre-programmed sound field

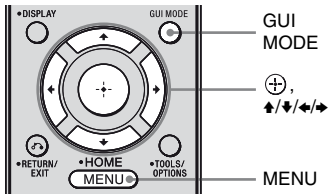

- 1 Start playing a sound source you want to listen to (CD, DVD, etc.).**
- 2 Press GUI MODE repeatedly to select “GUI ON”.**

The GUI menu appears on the TV screen. Press MENU if the GUI menu does not appear on the TV screen.
- 3 Press \uparrow/\downarrow repeatedly to select “Settings”, then press \oplus or \rightarrow .**

The Settings menu list appears on the TV screen.
- 4 Press \uparrow/\downarrow repeatedly to select “Surround”, then press \oplus or \rightarrow .**
- 5 Press \uparrow/\downarrow repeatedly to select “Sound Field Setup”, then press \oplus .**

- 6 Press \uparrow/\downarrow repeatedly to select the sound field you want.**

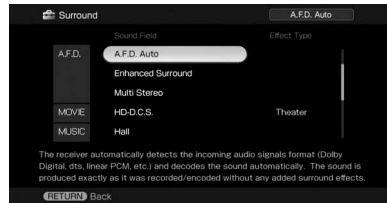

To select the Enhanced Surround mode

- 1 Select “Enhanced Sur Mode” in step 5.**
- 2 Press \uparrow/\downarrow repeatedly to select the enhanced surround sound you want.**
- 3 Press \oplus .**

Note

The selected Enhanced Surround mode can only be applied if you have selected “Enhanced Surround” as a sound field in the “Sound Field Setup” parameter.

To select the Effect Type for HD-D.C.S.

- 1 Press **▲/▼** repeatedly to select “Sound Field Setup”, then press **(+)**.
- 2 Press **▲/▼** repeatedly to select “HD-D.C.S.”, then press **➡**.
- 3 Press **▲/▼** to select the Effect Type you want, then press **←**.
HD-D.C.S. has three different types: Theater, Dynamic, and Studio. Each type has different reflection and reverberation sound mixture levels and is optimized to match a listener’s room uniqueness, taste and mood.
 - Theater
Theater type (default setting) mixes reflection and reverberation sound creating the characteristics of a mastering studio. Additionally, this type mixes in frequency characteristics that are often found in professional studios and movie theaters. It is ideal for watching movies in a listening room that has less reverberation.
 - Dynamic
Want to enjoy the sound effects to the full extent, just like at the movie theaters? Dynamic type emphasizes on the reflection sound. Without HD-D.C.S., many rooms are often somewhat reverberant but lack a spacious feeling. This type acoustically opens up those types of rooms and provides a spacious and dynamism feeling equivalent to a mastering studio.
 - Studio
In Studio type, effects are kept to a minimum, while still providing a great theater experience. This type provides the accuracy of the original recording.
- 4 Press RETURN/EXIT **↵**.

Types of 2CH mode

■ 2ch Stereo

The receiver outputs the sound from the front left/right speakers only. There is no sound from the subwoofer.

Standard 2 channel stereo sources completely bypass the sound field processing and multi channel surround formats are downmixed to 2 channel except LFE signals.

Note

No sound is output from the subwoofer in the 2ch Stereo mode. To listen to 2 channel stereo sources using the front left/right speakers and a subwoofer, select “A.F.D. Auto”.

This receiver will generate a low frequency signal for output to the subwoofer when there is no LFE signal, which is a low-pass sound effect output from a subwoofer to a 2 channel signal.

■ 2ch Analog Direct

You can switch the audio of the selected input to 2 channel analog input. This function enables you to enjoy high quality analog sources.

When using this function, only the volume and front speaker balance can be adjusted.

When connecting Blu-ray disc players and other next generation HD players

This receiver supports the following audio formats.

Audio format	Maximum number of channels	Connection of the playback component and the receiver	
		COAXIAL/OPTICAL	HDMI
Dolby Digital	5.1ch	○	○
Dolby Digital EX	6.1ch	○	○
Dolby Digital Plus ^{a)}	7.1ch	×	○
Dolby TrueHD ^{a)}	7.1ch	×	○
DTS	5.1ch	○	○
DTS-ES	6.1ch	○	○
DTS 96/24	5.1ch	○	○
DTS-HD High Resolution Audio ^{a)}	7.1ch	×	○
DTS-HD Master Audio ^{a) b)}	7.1ch	×	○
Multi channel Linear PCM ^{a)}	7.1ch	×	○

^{a)} Audio signals are output in another format if the playback component does not correspond to the format. For details, refer to the operating instructions of the playback component.

^{b)} Signals with a sampling frequency of 176.4 kHz and higher are played back at 96 kHz.

Types of A.F.D. mode

The Auto Format Direct (A.F.D.) mode allows you to listen to higher fidelity sound and select the decoding mode for listening to a 2 channel stereo sound as multi channel sound.

A.F.D. mode	Multi channel audio after decoding	Effect
A.F.D. Auto	(Detecting automatically)	Presets the sound as it was recorded/encoded without adding any surround effects.
Enhanced Surround		
Pro Logic II*	5-channel signals	Perform Dolby Pro Logic II decoding.
Pro Logic IIX*	7-channel signals	Perform Dolby Pro Logic IIX decoding.
Neo:6 Cinema	7-channel signals	Perform DTS Neo:6 Cinema mode decoding.
Neo:6 Music	7-channel signals	Perform DTS Neo:6 Music mode decoding. This setting is ideal for normal stereo sources such as CDs.
Neural-THX	7-channel signals	Next generation of Neural-THX® Surround. In addition to stereo enhancement processing and pure discrete 5.1 surround sound, now capable for full 360° 7.1 surround sound playback from Neural-THX® surround encoded content.
Multi Stereo	(Multi Stereo)	Outputs 2 channel left/right signals from all speakers. However, sound may not be output from certain speakers depending on the speaker settings.

* Depending on the speaker pattern setting, the appropriate Enhanced Surround mode appears.

Notes

- This function does not work in the following cases.
 - The multi channel input is selected.
 - DTS-HD signals with a sampling frequency of 88.2 kHz and higher are being received.
 - Dolby TrueHD signals with a sampling frequency of 88.2 kHz and higher are being received.
 - PCM signals with a sampling frequency of 88.2 kHz and higher are being received.
- Neural-THX is not effective when a sampling frequency of 88.2 kHz and higher are being received or a 2 channel analog signal is input. The Neural-THX processing will be turned off automatically when another type of signal is input. The beginning of the sound may drop out when the SURROUND processing is turned on/off.

Tips

- You can identify the encoding format of DVD software, etc., by looking at the logo on the package.
- Dolby Pro Logic IIX decoding is effective when a multi channel signal is input.

If you connect a subwoofer

This receiver will generate a low frequency signal for output to the subwoofer when there is no LFE signal, which is a low-pass sound effect output from a subwoofer to a 2 channel signal. However, the low frequency signal is not generated for “Neo:6 Cinema” or “Neo:6 Music” when all speakers are set to “LARGE”. In order to take full advantage of the Dolby Digital bass redirection circuitry, we recommend setting the subwoofer’s cut off frequency as high as possible.

Types of music/movie mode

You can take advantage of surround sound simply by selecting one of the receiver's preprogrammed sound fields. They bring the exciting and powerful sound of movie theaters and concert halls into your home.

Sound field for	Sound field	Effect
Movie	HD-D.C.S.	HD-D.C.S. can realize precisely the sound effect on the movies when watching through Blu-ray and DVD software, etc. like how Movie Sound Designers' intended it to be. You can select the Effect Type for HD-D.C.S. For details, see "Enjoying a pre-programmed sound field" (page 59).
Music	Hall	Reproduces the acoustics of a classical concert hall.
	Jazz Club	Reproduces the acoustics of a jazz club.
	Live Concert	Reproduces the acoustics of a 300-seat live house.
	Stadium	Reproduces the feeling of a large open-air stadium.
	Sports	Reproduces the feeling of sports broadcasting.
	Portable Audio	Reproduces a clear enhanced sound image from your portable audio device. This mode is ideal for MP3 and other compressed music.
Headphone*	Headphone (2ch)	This mode is selected automatically if you use headphones when "2ch Stereo" mode or A.F.D. mode is selected. Standard 2 channel stereo sources completely bypass the sound field processing and multi channel surround formats are downmixed to 2 channels except LFE signals.
	Headphone (Direct)	Outputs the analog signals without processing by the tone, sound field, etc.
	Headphone (Multi)	This mode is selected automatically if you use headphones when the multi channel input is selected. Outputs the front analog signals from the MULTI CHANNEL INPUT jacks.

* You can select this sound field mode if the headphones are connected to the receiver.

Notes

- The sound fields for music and movie do not work in the following cases.
 - The multi channel input is selected.
 - DTS-HD signals with a sampling frequency of 88.2 kHz and higher are being received.
 - Dolby TrueHD signals with a sampling frequency of 88.2 kHz and higher are being received.
 - PCM signals with a sampling frequency of 88.2 kHz and higher are being received.
- When one of the sound fields for music is selected, no sound is output from the subwoofer if all the speakers are set to "LARGE" in the Speaker settings menu. However, the sound will be output from the subwoofer if the digital input signal contains LFE signals, or if the front or surround speakers are set to "SMALL", the sound field for movie is selected, or "Portable Audio" is selected.
- If there is any noise present, the noise may be different depending on the sound field you select.

Tips

- For details on HD-D.C.S. technology, see “Glossary” (page 132).
- When a sound field with HD-D.C.S. is selected, the HD-D.C.S. lamp lights up on the display window.

To turn off the surround effect for MOVIE/MUSIC

Select “2ch Stereo” or “A.F.D. Auto” in the Surround settings menu.

Resetting sound fields to the initial settings

Be sure to use the buttons on the receiver for this operation.

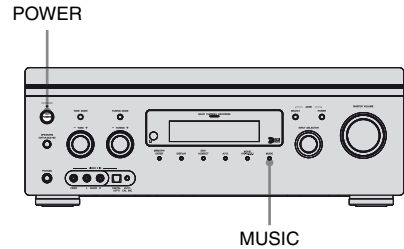

- 1 Press POWER to turn off the receiver.**
- 2 While holding down MUSIC, press POWER.**

“S.F. CLEAR” appears on the display window and all sound fields are reset to their initial setting.

Enjoying the surround effect at low volume levels

(NIGHT MODE)

This function allows you to retain a theater like environment at low volume levels. This function can be used with other sound fields. When watching a movie late at night, you will be able to hear the dialog clearly even at a low volume level.

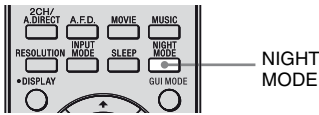

Press NIGHT MODE.

The NIGHT MODE function is activated. The NIGHT MODE is set to on and off as you press NIGHT MODE.

Note

- This function does not work in the following cases.
- The multi channel input is selected.
 - Dolby TrueHD signals with a sampling frequency of 176.4 kHz and higher are being received.
 - PCM signals with a sampling frequency of 176.4 kHz and higher are being received.

Advanced Speakers Set Up

Adjusting the speaker settings manually

You can adjust each speaker manually. You can also adjust the speaker levels after the Auto Calibration is completed.

Making settings with the Manual Setup menu

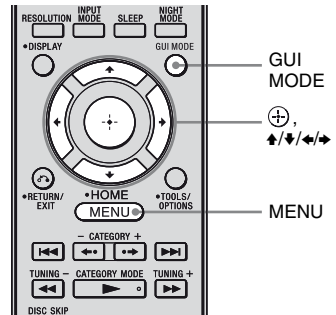

- 1 Press GUI MODE repeatedly to select "GUI ON".**
The GUI menu appears on the TV screen. Press MENU if the GUI menu does not appear on the TV screen.
- 2 Press ↑/↓ repeatedly to select "Settings", then press ⊕ or ➔.**
The Settings menu list appears on the TV screen.
- 3 Press ↑/↓ repeatedly to select "Speaker", then press ⊕ or ➔.**

- 4** Press **▲/▼** repeatedly to select “Manual Setup”, then press **⊕**.

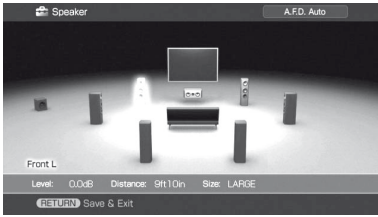

- 5** Press **▲/▼/◀/▶** repeatedly to select speaker you want to adjust.

- 6** Press **⊕**.

- 7** Press **◀/▶** repeatedly to select the parameter you want.

- 8** Press **▲/▼** repeatedly to adjust the setting.

Manual Setup menu parameters

■ Level (Level of speaker)

You can adjust each speaker's level (center, surround left/right, surround back left/right, subwoofer). You can adjust the level from -20 dB to $+10$ dB in 0.5 dB steps.

For the front left/right speakers, you can adjust the balance on either side. You can adjust the front left level from -10.0 dB to $+10.0$ dB in 0.5 dB steps. You can also adjust the front right level from -10.0 dB to $+10.0$ dB in 0.5 dB steps.

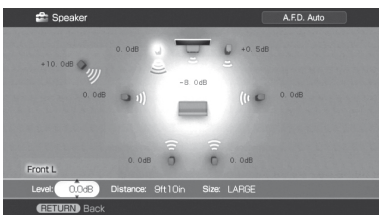

■ Distance (Distance from the seating position to each speaker)

You can adjust the distance from the seating position to each speaker (front left/right, center, surround left/right, surround back left/right, subwoofer).

You can adjust the distance from 3 feet 3 inches to 32 feet 9 inches (1.00 meter to 10.00 meters) in 1 inch (0.01 meter) steps.

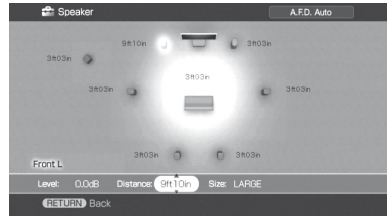

■ Size (Size of each speaker)

You can adjust each speaker's (front left/right, center, surround left/right, surround back left/right) size.

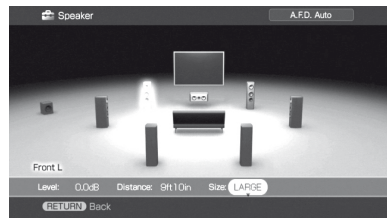

- **LARGE**

If you connect large speakers that will effectively reproduce bass frequencies, select “LARGE”. Normally, select “LARGE”.

- **SMALL**

If the sound is distorted, or you feel a lack of surround effects when using multi channel surround sound, select “SMALL” to activate the bass redirection circuitry and output the bass frequencies of each channel from the subwoofer or other “LARGE” speakers.

Note

When one of the sound fields for music is selected, no sound is output from the subwoofer if all the speakers are set to “LARGE”. However, the sound will be output from the subwoofer if the digital input signal contains LFE signals, or if the front or surround speakers are set to “SMALL”, the sound field for movie is selected, or “Portable Audio” is selected.

Tips

- The “LARGE” and “SMALL” settings for each speaker determine whether the internal sound processor will cut the bass signal from that channel.
- When the bass is cut from a channel, the bass redirection circuitry sends the corresponding bass frequencies to the subwoofer or other “LARGE” speakers.
- However, since bass sound has a certain amount of directionality, it is best not to cut it, if possible.
- Therefore, even when using small speakers, you can set them to “LARGE” if you want to output the bass frequencies from that speaker. On the other hand, if you are using a large speaker, but prefer not to have bass frequencies output from that speaker, set it to “SMALL”.
- If the overall sound level is lower than you prefer, set all speakers to “LARGE”. If there is not enough bass, you can use the equalizer to boost the bass levels.
- The surround back speakers will be set to the same setting as that of the surround speakers.
- When the front speakers are set to “SMALL”, the center, surround, and surround back speakers are also automatically set to “SMALL”.
- If you do not use the subwoofer, the front speakers are automatically set to “LARGE”.

Making settings with the Speaker Pattern menu

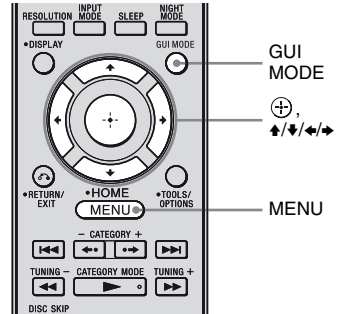

- 1 Press GUI MODE repeatedly to select “GUI ON”.**
 The GUI menu appears on the TV screen. Press MENU if the GUI menu does not appear on the TV screen.
- 2 Press \uparrow/\downarrow repeatedly to select “Settings”, then press \oplus or \rightarrow .**
 The Settings menu list appears on the TV screen.
- 3 Press \uparrow/\downarrow repeatedly to select “Speaker”, then press \oplus or \rightarrow .**
- 4 Press \uparrow/\downarrow repeatedly to select “Speaker Pattern”, then press \oplus .**
 Select “Speaker Pattern” according to the speaker system which you are using. You do not need to select the speaker pattern after Auto Calibration.

- 5 Press \uparrow/\downarrow repeatedly to select the speaker pattern you want.

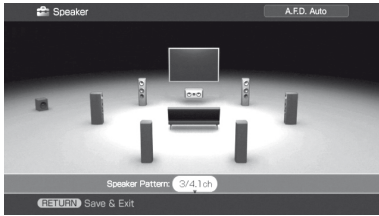

Making settings with the Test Tone menu

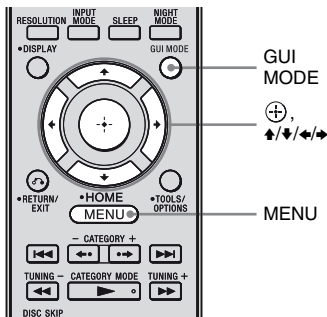

- 1 Press GUI MODE repeatedly to select “GUI ON”.
The GUI menu appears on the TV screen. Press MENU if the GUI menu does not appear on the TV screen.
- 2 Press \uparrow/\downarrow repeatedly to select “Settings”, then press \odot or \rightarrow .
The Settings menu list appears on the TV screen.
- 3 Press \uparrow/\downarrow repeatedly to select “Speaker”, then press \odot or \rightarrow .

- 4 Press \uparrow/\downarrow repeatedly to select “Test Tone”, then press \odot .

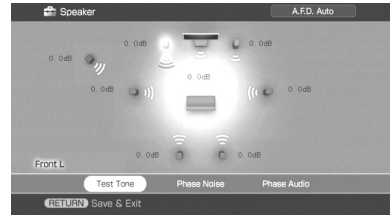

- 5 Press \leftarrow/\rightarrow repeatedly to select test tone type, then press \odot .
- 6 Press \uparrow/\downarrow repeatedly to select the speaker you want to adjust, then press \odot .
The test tone is output from each speaker in sequence.
- 7 Press \uparrow/\downarrow repeatedly to adjust the parameter, then press \odot .

Tips

- To adjust the level of all speakers at the same time, press MASTER VOL +/-.
- The adjusted value is shown on the display during adjustment.

When a test tone is not output from the speakers

- The speaker cords may not be connected securely. Check to see if they are connected securely and cannot be disconnected by pulling on them slightly.
- The speaker cords may have the short-circuit problem.

When a test tone is output from a different speaker than the speaker displayed on the screen

The speaker pattern to the connected speaker is not set up correctly. Make sure the speaker connection and the speaker pattern match.

Test Tone menu parameters

■ Test Tone (Test Tone)

- OFF
- AUTO
The test tone is output from each speaker in sequence.
- L, C, R, SR, SB, SBR, SBL, SL, SW
You can select which speakers will output the test tone.
Some items may not be displayed, depending on the setting of the speaker pattern.

■ Phase Noise (Phase Noise)

- OFF
- L/C, C/R, L/R, R/SL, R/SR, SR/SL, SR/SBR, SBR/SBL, SR/SB, SBL/SL, SB/SL, SL/L, L/SR
Lets you output the test tone sequentially from adjacent speakers.
Some items may not be displayed, depending on the setting of the speaker pattern.

■ Phase Audio (Phase Audio)

- OFF
- L/C, C/R, L/R, R/SL, R/SR, SR/SL, SR/SBR, SBR/SBL, SR/SB, SBL/SL, SB/SL, SL/L, L/SR
Lets you output the front 2 channel source sound (instead of the test tone) sequentially from adjacent speakers.
Some items may not be displayed, depending on the setting of the speaker pattern.

Other menu parameters of Speaker settings

■ Sur Back Assign (Settings of the surround back speaker(s))

- OFF
If you have not connected surround back speakers, select “OFF”.
- BI-AMP
If you connect front speakers in a bi-amplifier configuration, select “BI-AMP”.
- ZONE2
If you are using the surround back speakers in zone 2, select “ZONE2”. When you select “ZONE2”, the input to the SUR BACK jacks of the MULTI CHANNEL INPUT is invalid.

Note

Set “Sur Back Assign” to “OFF”, then connect the surround back speakers to this receiver when you want to change the connection from a bi-amplifier connection or a zone 2 connection to a surround back speakers connection. Set up the speakers again after you connect the surround back speakers. See “9: Calibrating the appropriate speaker settings automatically (Auto Calibration)” (page 44) or “Adjusting the speaker settings manually” (page 65).

■ Crossover Freq (Speaker crossover frequency)

Lets you set the bass crossover frequency of speakers that has been set to “SMALL” in the Speaker settings menu. Measured speaker crossover frequency is set for each speaker after the Auto Calibration.
The adjusted value is set for each speaker when you adjust the speaker crossover frequency using “Crossover Freq” after the Auto Calibration.

■ D. Range Comp (Dynamic range compressor)

Lets you compress the dynamic range of the sound track. This may be useful when you want to watch movies at low volumes late at night. Dynamic range compression is possible with Dolby Digital sources only.

- OFF
The dynamic range is not compressed.
- AUTO
The dynamic range is applied automatically with Dolby TrueHD source and is set to “OFF” with other sources.
- STD
The dynamic range is compressed as intended by the recording engineer.
- MAX
The dynamic range is compressed dramatically.

Tips

- Dynamic range compressor lets you compress the dynamic range of the soundtrack based on the dynamic range information included in the Dolby Digital signal.
- “STD” is the standard setting, but it only enacts light compression. Therefore, we recommend using the “MAX” setting. This greatly compresses the dynamic range and lets you view movies late at night at low volumes. Unlike analog limiters, the levels are predetermined and provide a very natural compression.

■ Distance Unit (Distance unit)

Lets you select the unit of measure for setting distances.

- meter
The distance is displayed in meters.
- feet
The distance is displayed in feet.

Adjusting the equalizer

You can use following parameters to adjust the tonal quality (bass/treble level) of all speakers.

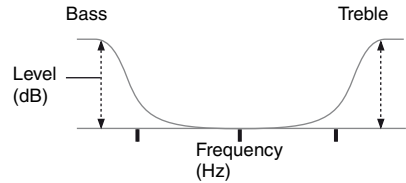

Note

This function does not work in the following cases.

- The multi channel input is selected.
- “2ch Analog Direct” is being used.
- Dolby TrueHD signals with a sampling frequency of 176.4 kHz and higher are being received.
- PCM signals with a sampling frequency of 176.4 kHz and higher are being received.

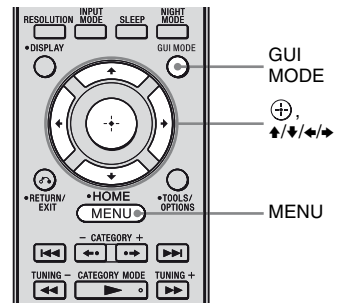

1 Press GUI MODE repeatedly to select “GUI ON”.

The GUI menu appears on the TV screen. Press MENU if the GUI menu does not appear on the TV screen.

2 Press \uparrow/\downarrow repeatedly to select “Settings”, then press \oplus or \rightarrow .

The Settings menu list appears on the TV screen.

- 3** Press \uparrow/\downarrow repeatedly to select “EQ”, then press \oplus .

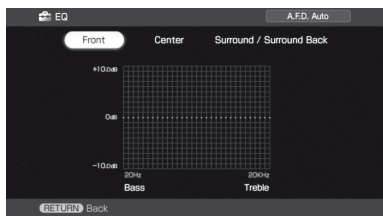

- 4** Press \leftarrow/\rightarrow repeatedly to select the speaker you want to adjust, then press \oplus .

- 5** Press \leftarrow/\rightarrow repeatedly to select “Bass” or “Treble”, then press \uparrow/\downarrow to adjust the parameter.

Tip

You can adjust the front speaker bass and treble level with TONE MODE and TONE +/- on the receiver.

- 6** Press \oplus to enter the setting.

Tuner Operations

Listening to FM/AM radio

You can listen to FM and AM broadcasts through the built-in tuner. Before operation, make sure you have connected the FM and AM antennas (aerials) to the receiver (page 36).

Tip

The tuning scale for direct tuning is shown below.

- FM band 100 kHz
- AM band 10 kHz*

* The AM tuning scale can be changed (page 142).

Automatic tuning

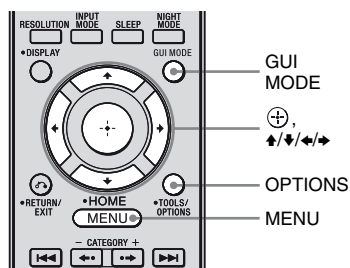

- 1** Press GUI MODE repeatedly to select “GUI ON”.

The GUI menu appears on the TV screen. Press MENU if the GUI menu does not appear on the TV screen.

- 2** Press \uparrow/\downarrow repeatedly to select “FM” or “AM”, then press \oplus or \rightarrow .

The FM or AM menu list appears on the TV screen.

- 3** Press \uparrow/\downarrow to select “Auto Tuning”, then press \oplus .



- 4** Press \uparrow/\downarrow .

Press \uparrow to scan from low to high, press \downarrow to scan from high to low. The receiver stops scanning whenever a station is received.

In case of poor FM stereo reception

- 1 Press OPTIONS.
- 2 Press \uparrow/\downarrow to select “FM Mode”, then press \oplus or \rightarrow .
- 3 Press \uparrow/\downarrow to select “MONO”, then press \oplus .

Direct tuning

Enter the frequency of a station directly by using the numeric buttons.

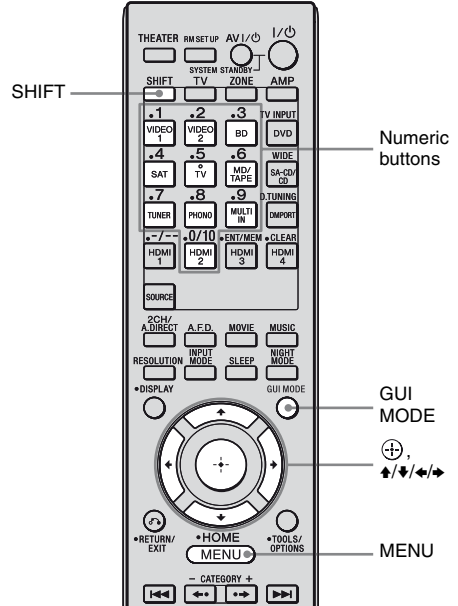

- 1** Press GUI MODE repeatedly to select “GUI ON”.

The GUI menu appears on the TV screen. Press MENU if the GUI menu does not appear on the TV screen.

- 2** Press \uparrow/\downarrow repeatedly to select “FM” or “AM”, then press \oplus or \rightarrow .

- 3** Press \uparrow/\downarrow to select “Direct Tuning”, then press \oplus .

4 Press SHIFT, then press the numeric buttons to enter the frequency, then press \oplus .

Example 1: FM 102.50 MHz

Select 1 \rightarrow 0 \rightarrow 2 \rightarrow 5

Example 2: AM 1,350 kHz

Select 1 \rightarrow 3 \rightarrow 5 \rightarrow 0



Tip

If you have tuned in an AM station, adjust the direction of the AM loop antenna (aerial) for optimum reception.

If you cannot tune in a station

“---.--- MHz” appears and then the display returns to the current frequency.

Make sure you have entered the right frequency. If not, repeat step 4. If you still cannot tune in a station, the frequency is not used in your area.

Presetting radio stations

You can preset up to 30 FM and 30 AM stations. Then you can easily tune in the stations you often listen to.

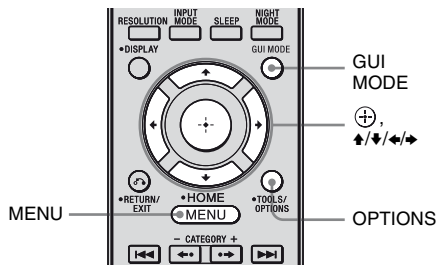

1 Press GUI MODE repeatedly to select “GUI ON”.

The GUI menu appears on the TV screen. Press MENU if the GUI menu does not appear on the TV screen.

2 Press \uparrow/\downarrow repeatedly to select “FM” or “AM”, then press \oplus or \rightarrow .

3 Tune in the station that you want to preset using Automatic Tuning (page 71) or Direct Tuning (page 72).

In case of poor FM stereo reception, switch the FM reception mode (page 72).

4 Press OPTIONS.

5 Press \uparrow/\downarrow to select “Memory”, then press \oplus .

6 Press \uparrow/\downarrow to select a preset number.

7 Press \oplus .

The station is stored as the selected preset number.

8 Repeat steps 3 to 7 to preset another station.

To tune to preset stations

- 1** Repeat steps 1 and 2 of “Presetting radio stations”.
- 2** Press **▲/▼** to select the preset station you want.
You can select a preset station as follows:
 - AM band AM 1 to AM 30
 - FM band FM 1 to FM 30

To name preset stations

- 1** Select a preset station you want to name.
- 2** Press **OPTIONS**, then select “Name Input”.
For details on naming operations, see “Naming inputs” (page 101).

Listening to Satellite Radio

To listen to Satellite Radio, you’ll need to connect either a SIRIUS or XM Satellite Radio tuner (sold separately) to your satellite-ready receiver. Satellite Radio is available to residents of the US (except Alaska and Hawaii) and Canada.

Satellite Radio delivers a variety of commercial-free music from categories ranging from Pop, Rock, Country, R&B, Dance, Jazz, Classical and many more plus coverage of all the top professional and college sports including play by play games from select leagues and teams. Additional programming includes expert sports talk, uncensored entertainment, comedy, family programming, local traffic and weather and news from your most trusted sources.

Whether you purchase a SIRIUS or XM tuner, you’ll need to activate and subscribe to begin enjoying the service. Easy to follow installation and setup instructions are provided with the satellite tuners. Whichever service you choose, there are a variety of programming packages available, including the option of adding “The Best of SIRIUS” programming to your XM tuner or “The Best of XM” programming to your SIRIUS tuner, enabling you to enjoy the most popular programming among both services. The “Best of” packages are not available to SIRIUS or XM Canada subscribers at this time.

Family friendly packages are also available to restrict channels featuring content that may be inappropriate for children.

To subscribe to XM, U.S. customers should visit xmradio.com or call 1-800-XMRADIO (1-800-967-2346); Canadian customers should visit xmradio.ca or call XM Listener Care at 1-877-GETXMSR (1-877-438-9677).

To subscribe to SIRIUS, U.S. and Canadian customers can call 1-888-539-SIRI (1-888-539-7474) or visit sirius.com (US) or siriuscanada.ca (Canada).

SIRIUS, XM and all related marks and logos are trademarks of Sirius XM Radio Inc. and its subsidiaries. All other marks and logos are the property of their respective owners. All rights reserved. SIRIUS and XM subscriptions sold separately. Taxes and a one-time activation fee may apply. XM tuners and home docks or SIRIUS tuners (each sold separately) are required to receive the SIRIUS or XM satellite radio service. All programming and fees subject to change. It is prohibited to copy, decompile, disassemble, reverse engineer, hack, manipulate or otherwise make available any technology or software incorporated in receivers compatible with the SIRIUS or XM Satellite Radio Systems.

Service not available in Alaska or Hawaii.

Connecting the XM Radio or SIRIUS Satellite Radio

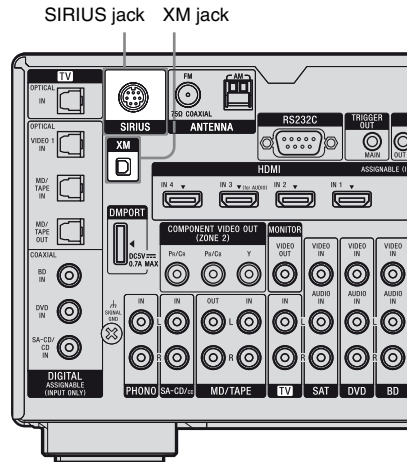

To connect to the XM jack

Before operating the system, connect the XM Mini Tuner and Home Dock to the XM jack.

Note

To ensure optimal reception of XM's satellite signal, move your antenna to various window locations around your home to see where the best reception will be received. Most XM customers place the antenna in a south-facing window with a clear view to the sky.

To connect to the SIRIUS jack

Connect the SiriusConnect Home tuner. When you use the SiriusConnect Home tuner with this receiver, be sure to connect the AC power adaptor supplied with the tuner to a wall outlet. Keep the SiriusConnect Home tuner, antenna, and AC power adaptor away from the speaker cords and the power cord to avoid picking up noise.

Aiming the XM Radio or SIRIUS antenna

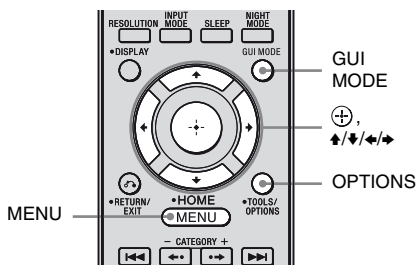

1 Press GUI MODE repeatedly to select “GUI ON”.

The GUI menu appears on the TV screen. Press MENU if the GUI menu does not appear on the TV screen.

2 Press \uparrow/\downarrow repeatedly to select “XM” or “SIRIUS”, then press \oplus or \ominus .

3 Press OPTIONS, then press \uparrow/\downarrow repeatedly to select “Antenna Aiming”, then press \oplus .

XM

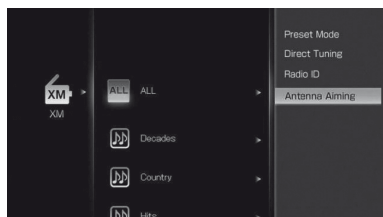

SIRIUS

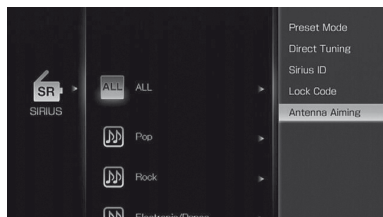

4 While checking the parameter on the TV screen, aim your antenna to where the best reception will be received.

XM

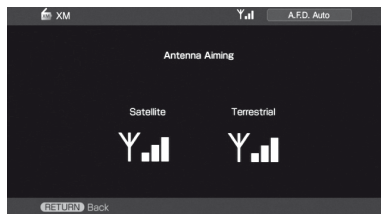

SIRIUS

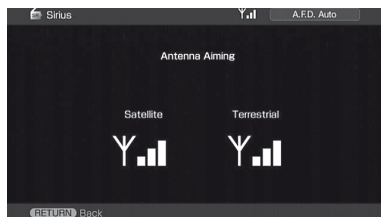

Checking the XM Radio ID or SIRIUS ID number

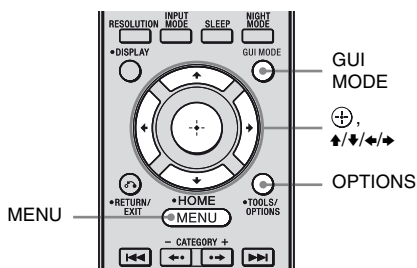

1 Press GUI MODE repeatedly to select “GUI ON”.

The GUI menu appears on the TV screen. Press MENU if the GUI menu does not appear on the TV screen.

- 2** Press \uparrow/\downarrow repeatedly to select “XM” or “SIRIUS”, then press \oplus or \rightarrow .

XM

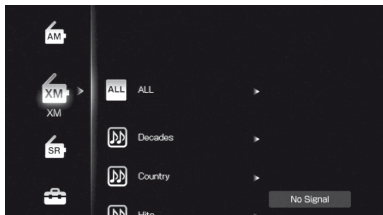

SIRIUS

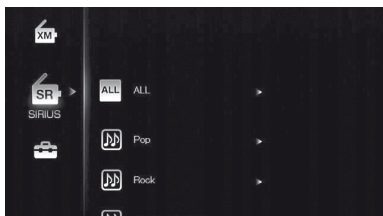

- 3** Press **OPTIONS**, then press \uparrow/\downarrow repeatedly to select “Radio ID” or “Sirius ID”, then press \oplus .

XM

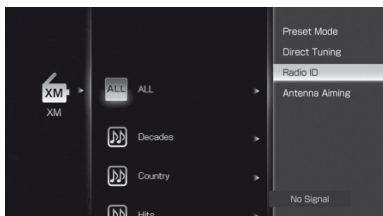

SIRIUS

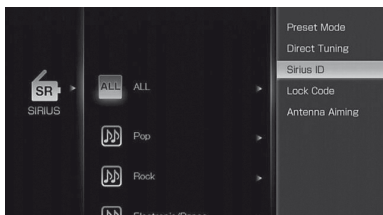

- 4** Check the XM Radio ID or Sirius ID on the TV screen and write it in the space provided here.

XM Radio ID: _____
SIRIUS ID: _____

You can also check the XM Radio ID and SIRIUS ID using the display on the receiver.

Selecting a channel by Category Mode

You can select a channel from one category or all the categories.

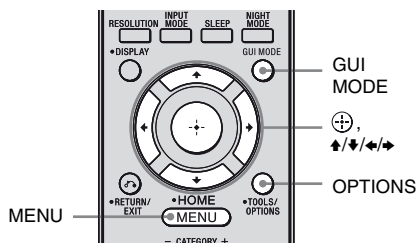

- 1** Press **GUI MODE** repeatedly to select “GUI ON”.

The GUI menu appears on the TV screen. Press **MENU** if the GUI menu does not appear on the TV screen.

- 2** Press \uparrow/\downarrow repeatedly to select “XM” or “SIRIUS”, then press \oplus or \rightarrow .

3 Press \uparrow/\downarrow repeatedly to select the category, then press \odot .

- ALL: You can select a channel from all the categories.
- (category name): You can select a channel from one category.

XM

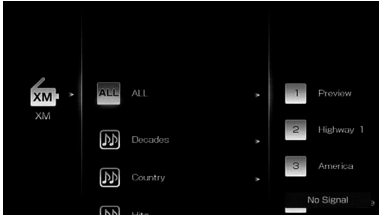

SIRIUS

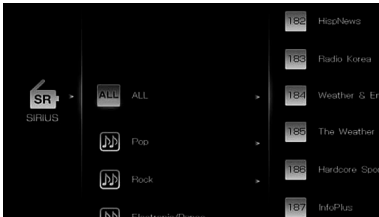

When the “Preset Mode” screen is displayed, press OPTIONS, then press \uparrow/\downarrow repeatedly to select “Category Mode”.

4 Press \uparrow/\downarrow to select the channel, then press \odot .

The selected channel is being received. The channel information is displayed on the TV screen.

Note

When you select a channel in the “Category Mode”, the channel you selected may not be the one in the category you want. This is because one channel may belong to more than one category.

Selecting a channel by inputting the channel number directly

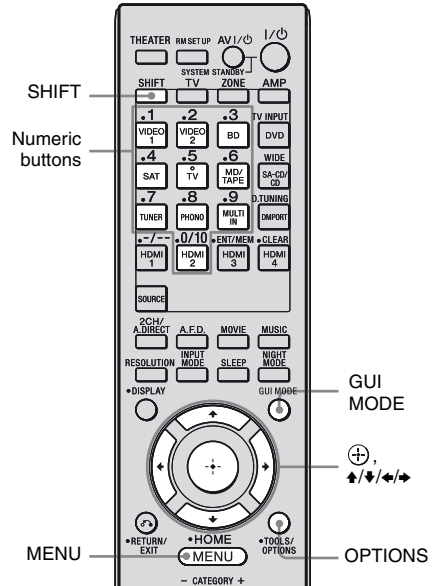

1 Press GUI MODE repeatedly to select “GUI ON”.

The GUI menu appears on the TV screen. Press MENU if the GUI menu does not appear on the TV screen.

2 Press \uparrow/\downarrow repeatedly to select “XM” or “SIRIUS”, then press \odot or \rightarrow .

3 Press OPTIONS.

4 Press \uparrow/\downarrow to select “Direct Tuning”, then press \odot .

5 Press SHIFT, then press the numeric buttons to enter the channel number.

6 Press \odot .

The selected channel is tune in.

Presetting the channels

You can select the channels you want directly by presetting them using the preset numbers. You can preset up to 30 XM Radio channels and 30 SIRIUS Satellite Radio channels.

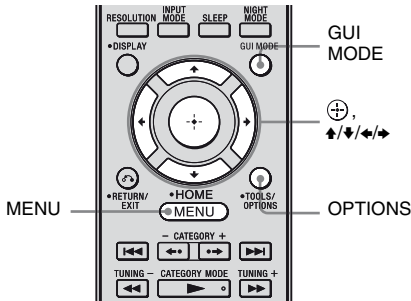

- 1 Press GUI MODE repeatedly to select “GUI ON”.**

The GUI menu appears on the TV screen. Press MENU if the GUI menu does not appear on the TV screen.

- 2 Press \uparrow/\downarrow repeatedly to select “XM” or “SIRIUS”, then press \oplus or \rightarrow .**

- 3 Select a channel you want to preset using Category Tuning (page 77) or Direct Tuning (page 78).**

- 4 Press OPTIONS.**

- 5 Press \uparrow/\downarrow to select “Memory”, then press \oplus .**

- 6 Press \uparrow/\downarrow repeatedly to select the preset channel you want to use as the preset channel, then press \oplus .**

Preset channels from 1 to 30 are available, and a default channel is preset for all the preset channels when you purchase the receiver.

The selected channel is registered as the preset channel you selected in step 3.

- 7 Repeat steps 3 to 6 to preset another channel.**

To select the preset channels

- Repeat steps 1 and 2 of “Presetting the channels”.
- Press \uparrow/\downarrow to select the preset number from the preset list, then press \oplus . You can select stored preset channels from 1 to 30.

Notes

- The channel information you have preset may be changed if XM Satellite Radio Inc. or SIRIUS Satellite Radio Inc. change their channel programming.
- When the “Category Mode” screen is displayed, press OPTIONS, then press \uparrow/\downarrow to select “Preset Mode”.

Restricting access to specific channels (Parental Lock) (SIRIUS only)

You can restrict access to certain channels using your own lock code. The lock code is set to “0000” as the default.

Change the lock code before you use this function for the first time (see “To change the lock code” (page 81)).

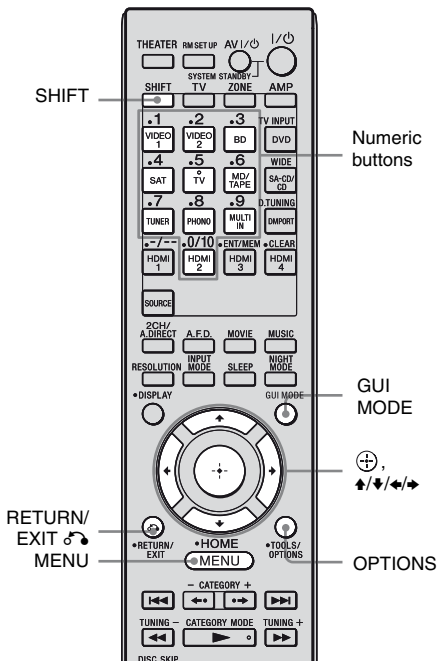

1 Press GUI MODE repeatedly to select “GUI ON”.

The GUI menu appears on the TV screen. Press MENU if the GUI menu does not appear on the TV screen.

2 Press \uparrow/\downarrow repeatedly to select “SIRIUS”, then press \oplus or \rightarrow .

3 Select a channel you want to lock using Category Tuning (page 77) or Direct Tuning (page 78).

4 Press OPTIONS, then press \uparrow/\downarrow to select “Parental Lock”, then press \oplus or \rightarrow .

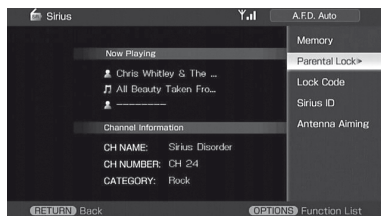

5 Press \uparrow/\downarrow repeatedly to select “ON”, then press \oplus .

“Enter your 4-digit lock code.” appears.



- 6** Press SHIFT, then press the numeric buttons to enter your 4-digit lock code.

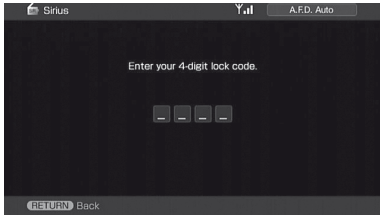

“The channel has been locked.” appears and the Parental Lock is set.

To delete the numbers you have entered, go back to step 4 by pressing RETURN/EXIT , and then repeat the procedure above from step 4.

To change the lock code

- 1 Press \uparrow/\downarrow repeatedly to select “SIRIUS”, then press \oplus or \rightarrow .
- 2 Press OPTIONS, then press \uparrow/\downarrow to select “Lock Code”, then press \oplus . “Enter your 4-digit lock code.” appears.
- 3 Press SHIFT, then press the numeric buttons to enter your 4-digit lock code. “Enter a new lock code.” appears.
- 4 Enter a new 4-digit lock code using the numeric buttons. “To confirm, enter your new lock code again.” appears.
- 5 Reenter the new lock code with the numeric buttons. “The lock code has been changed.” appears.

To listen to the locked channels

- 1 Press \uparrow/\downarrow repeatedly to select “SIRIUS”, then press \oplus or \rightarrow .
- 2 Select a locked channel you want to listen to using “Direct Tuning” (page 78). “The channel is locked. Enter your 4-digit lock code.” appears.
- 3 Press SHIFT, then press the numeric buttons to enter your 4-digit lock code. The channel is tuned in.

To cancel the Parental Lock

- 1 Press \uparrow/\downarrow repeatedly to select “SIRIUS”, then press \oplus or \rightarrow .
- 2 Tune in the channel you want to unlock using “Direct Tuning” (page 78).
- 3 Press OPTIONS, then press \uparrow/\downarrow to select “Parental Lock”, then press \oplus or \rightarrow .
- 4 Press \uparrow/\downarrow repeatedly to select “OFF”, then press \oplus . “Enter your 4-digit lock code.” appears.
- 5 Press SHIFT, then press the numeric buttons to enter your 4-digit lock code. “The channel has been unlocked.” appears and the channel is unlocked.

Notes

- When you select a channel using Category Tuning, locked channels are skipped.
- When the receiver is reset to the factory settings, the lock code returns to the default (0000), but the Parental Lock settings are not removed.
- You cannot preset locked channels. If you set the Parental Lock for a preset channel, the preset information for that channel returns to the default.
- You cannot set the Parental Lock for channel 0 or channel 184.

XM Radio message list

Message appears in GUI menu [Display window]	Explanation	Remedies
Check Antenna [ANTENNA]	The XM antenna is not connected to the XM Mini-Tuner and Home Dock or the XM antenna cable is damaged.	Check that the XM antenna is connected to the XM Mini-Tuner and Home Dock securely and check the antenna cable for damage. Replace the XM antenna if the cable is damaged.
CH Unauthorized [UNAUTH]	You have selected an XM channel that is blocked or cannot be received with your XM subscription package.	Consult the latest channel guide at www.xmradio.com (US residents) or www.xmradio.ca (Canadian residents) for the current list of channels. For information on receiving this channel, visit www.xmradio.com (US residents) or www.xmradio.ca (Canadian residents). You can also contact XM Satellite Radio at 1-800-967-2346 (US residents) or 1-877-438-9677 (Canadian residents).
No Signal [NO SIGNAL]	The XM Mini-Tuner is not receiving the XM satellite signal. The XM antenna's view of the satellites may be blocked or the antenna is not properly aimed.	Check the antenna for obstructions and reposition the XM antenna to get a better signal reception. To optimize the antenna position, see "Aiming the XM Radio or SIRIUS antenna" (page 76). Refer to the operating instructions supplied with the XM Mini-Tuner and Home Dock for antenna installation information.
Loading [LOADING]	The XM Mini-Tuner is acquiring audio or program information from the XM satellite signal. This message can also occur in weak XM signal conditions.	This message should disappear in a few seconds when the signal is strong. If you often see this message, reposition the XM antenna for better signal reception. To optimize the antenna position, see "Aiming the XM Radio or SIRIUS antenna" (page 76).
Off Air [OFF AIR]	You have selected an XM channel that is not currently broadcasting.	Check this XM channel later. In the meantime, select another channel.
[-----]	No artist name or song title is available for this selection.	—
CH Unavailable [CH UNAVL]	The selected channel is not available. The channel may have been reassigned to a different channel number. This message may occur initially with a new radio or a radio that has not received XM's signal for an extended period.	Consult the latest channel guide at www.xmradio.com (US residents) or www.xmradio.ca (Canadian residents) for the current channel list. For a new radio or a radio that has not received XM's signal for an extended period, allow the radio to receive the XM satellite signal for at least 5 minutes and then select the channel again.
Check XM Tuner [XM TUNER]	The XM Mini-Tuner is not installed or not fully seated in the XM Mini-Tuner Home Dock or the XM Mini-Tuner Home Dock is not connected to the receiver.	Confirm the XM Mini-Tuner is fully seated in the dock and check the XM Mini-Tuner and Home Dock cable is connected to the receiver.

SIRIUS Satellite Radio message list

Message appears in GUI menu [Display window]	Explanation	Remedies
Antenna Error [ANTENNA]	The antenna is not connected properly.	Check the connection between the SiriusConnect Home tuner and the antenna.
Acquiring Signal [ACQUIRING]	The receiving condition is not good.	Try moving the antenna to another location. For details about the antenna location, refer to the instructions supplied with the SiriusConnect Home tuner.
CALL 888, 539-SIRI [CALL 888, 539-SIRI]	You have not subscribed for the selected channel.	—
Check Sirius Tuner [SR TUNER]	The SiriusConnect Home tuner is not connected properly.	Check all the connections, and then turn the system on again. Also make sure if the AC adaptor supplied with the SiriusConnect Home tuner is connected to a wall socket.
Invalid Channel [INVALID]	You have entered an invalid channel number.	The channel to be tuned-in is void due to the change by the broadcast service, or the receiving condition is not good.
Locked Channel [LOCKED CH]	The selected channel is locked.	—
Subscription Updated [SUB UPDT]	The subscription information has been updated.	—
Updating Channels ■■■% Completed (■■■ are for integers) [UPDATING]	Channel information is being updated.	—
Firmware Updating [FW UPDT]	The SiriusConnect Home tuner firmware is being updated.	—
[-----]	There is no text information in the channel.	This is not an error. The text information may not be displayed depending on the system condition, for example, right after the system has received a channel.

Using “BRAVIA” Sync features

What is “BRAVIA” Sync?

“BRAVIA” Sync is compatible with a Sony TV, Blu-ray Disc/DVD player, AV amplifier, etc., that is equipped with the Control for HDMI function.

By connecting Sony components that are compatible with the “BRAVIA” Sync with a HDMI cable (not supplied), operation is simplified as below:

- One-Touch Play (page 87)
- System Audio Control (page 88)
- System Power-Off (page 88)
- Theater Mode Sync (page 89)
- 24p Auto Sound Sync (page 89)

Control for HDMI is a mutual control function standard used by HDMI CEC (Consumer Electronics Control) for HDMI (High-Definition Multimedia Interface).

The Control for HDMI function does not work in the following cases:

- When you connect the receiver to a component which does not correspond with Sony Control for HDMI function.
- When you connect the receiver and components using other than HDMI connection.

We recommend that you connect the receiver to products featuring “BRAVIA” Sync.

Note

Depending on the connected component, the Control for HDMI function may not work. Refer to the operating instructions of the component.

Connecting a TV and other components

Before connecting cords, be sure to disconnect the AC power cord (mains lead).

To enjoy TV multi channel surround sound broadcasting

You can listen to TV multi channel surround sound broadcasting from the speakers connected to the receiver.

Connect the OPTICAL output jack of the TV to the OPTICAL IN jack of the receiver.

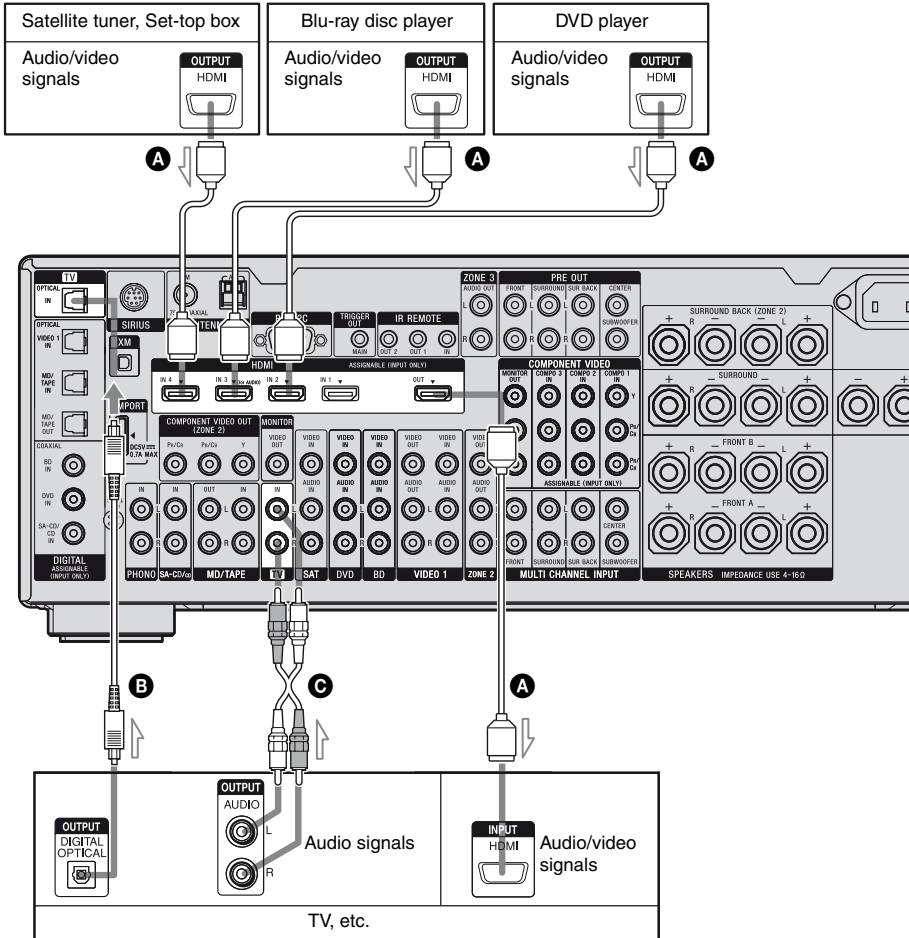

- A** HDMI cable (not supplied)
Sony recommends that you use an HDMI-authorized cable or Sony HDMI cable.
- B** Optical digital cord (not supplied)^{a)}
- C** Audio cord (not supplied)^{a)}

^{a)} Connect at least one of the audio cords (**B** or **C**).

Preparing Control for HDMI function

This receiver supports the Control for HDMI-Easy Setting function.

This function is only available for certain types of TV. When you perform the Control for HDMI-Easy Setting on the TV, the Control for HDMI setting on this receiver will automatically change accordingly.

During the Control for HDMI-Easy Setting operation, “SCANNING” flashes in the display window. This receiver will automatically change the input to HDMI input. When the setting is completed, “COMPLETE” appears on the display window.

For details, refer to the operating instructions of the TV.

If your TV does not support the Control for HDMI-Easy Setting function, do the following procedures. For details on setting the TV and the connected components, refer to the operating instructions of the respective components.

- 1 Make sure that the receiver is connected to the TV and components (compatible with Control for HDMI function) via HDMI connection.
- 2 Turn on the receiver, TV and connected components.
- 3 Set the respective Control for HDMI function for the receiver and TV to on. See “To set Control for HDMI” (page 87).
When the receiver menu is displayed on the TV screen in the screen mode, press GUI MODE repeatedly to select “GUI OFF” to enter the display mode, then check the TV display image of the component connected to the receiver.
For details on setting the TV, refer to the operating instructions of the TV.
- 4 Select the HDMI input of the receiver and TV to match the HDMI input of the connected component, so that the image from the connected component is displayed.

- 5 Set the Control for HDMI function for the connected component to on.
If the Control for HDMI function for the connected component is already set to on, you do not need to change the setting.
- 6 Repeat steps 4 and 5 for other components that you want to use the Control for HDMI function.

Notes

- If you unplug and reconnect the HDMI cable, be sure to repeat steps 1 to 6 above.
- You cannot perform One-Touch Play and System Audio Control during the Control for HDMI-Easy Setting operation.
- Before you do the Control for HDMI-Easy Setting from the TV, be sure to turn on the TV, connected components and receiver.
- If the playback components cannot function after you have made the settings for Control for HDMI-Easy Setting, check the Control for HDMI setting on your TV.
- If the connected components do not support the Control for HDMI-Easy Setting, you need to set the Control for HDMI function for the connected components to on before you perform the Control for HDMI-Easy Setting from the TV.

To set Control for HDMI

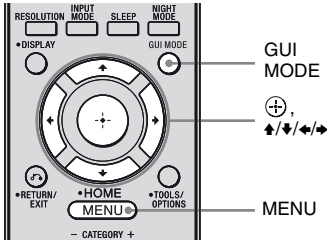

1 Press GUI MODE repeatedly to select “GUI ON”.

The GUI menu appears on the TV screen. Press MENU if the GUI menu does not appear on the TV screen.

2 Press \uparrow/\downarrow repeatedly to select “Settings” then press \leftarrow or \rightarrow .

The settings menu list appears on the TV screen.

3 Press \uparrow/\downarrow repeatedly to select “HDMI” then press \leftarrow or \rightarrow .

4 Press \uparrow/\downarrow repeatedly to select “Control for HDMI” then press \leftarrow .

5 Press \uparrow/\downarrow repeatedly to select “ON”, then press \leftarrow .

Control for HDMI function is activated.

Playing back components with one-touch operation (One-Touch Play)

With a simple operation (one-touch), components connected to the receiver via HDMI connections will start automatically. You can enjoy the sound and image from the connected components.

Play back a connected component.

The receiver and TV are turned on simultaneously, and the sound and image are output from the receiver and TV.

Note

Depending on the TV, the start of the content may not be output.

Enjoying the TV sound from the speakers connected to the receiver (System Audio Control)

You can enjoy the TV sound from the speakers connected to the receiver by a simple operation.

Depending on the TV settings, while you are watching the TV, the receiver turns on and switches to the “TV” function automatically. TV sound is output from the speakers connected to the receiver, and the volume of the TV is minimized simultaneously. You can also use the System Audio Control function as follows.

- The sound of the TV is output from the speakers connected to the receiver when you turn the receiver on while the sound is being output from the TV speaker.
- You can adjust the receiver’s volume when you adjust the TV volume.

You can also operate this function using the TV menu. For details, refer to the operating instructions of the TV.

Notes

- If System Audio Control does not function according to your TV setting, refer to the operating instructions of the TV.
- When “Control for HDMI” is set to “ON”, the “Audio Out” settings in the HDMI settings menu will set automatically depending on the System Audio Control settings.
- When you connect a TV that does not have System Audio Control function, the System Audio Control function does not work.
- If the TV is turned on before turning on the receiver, the TV sound will not be output for a moment.

Turning off the receiver with the TV (System Power-Off)

When you turn the TV off by using the POWER button on the TV’s remote, the receiver and the connected components turn off automatically.

You can also use the receiver’s remote to turn off the TV.

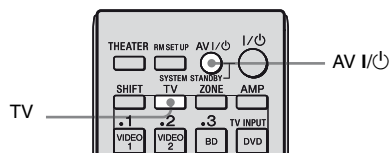

Press TV, then press AV I/O.

The TV, receiver and the components connected via HDMI are turned off.

Notes

- Set the TV Standby Synchro to “ON” before using the System Power Off function. For details, refer to the operating instructions of the TV.
- Depending on the status, the connected components may not be turned off. For details, refer to the operating instructions of the connected components.

Enjoying movies with the optimum sound field (Theater Mode Sync)

Press the THEATER button on the remote of the receiver, TV, or the Blu-ray Disc Player, while pointing the remote toward the TV.

The sound field switches to HD-D.C.S.

To return to the previous sound field, press the THEATER button again.

Note

The sound field may not switch depending on the TV.

Tip

The sound field may be changed back to the previous one when you change the TV's input.

24p Auto Sound Sync

This function switches the sound field to HD-D.C.S. automatically when 24p (24 frames per second) signals are input from a playback component, such as a Blu-ray Disc Player.

Play back content containing 24p signals on a playback component.

The sound field switches to HD-D.C.S.

If you do not want the sound field to switch to HD-D.C.S. automatically, set "24p Auto Sound Sync" to "OFF" (page 116).

Notes

- This function does not work if a player is not compatible with 24p Auto Sound Sync.
- When "Control for HDMI" is set to "ON", depending on the player, the sound field may not switch to HD-D.C.S.

When "Control for HDMI" is set to "ON", the receiver detects the 24p signals via "BRAVIA" Sync. Therefore, if a player that is not compatible with "BRAVIA" Sync sends out 24p signals, the receiver will not switch the sound field to HD-D.C.S. In this case, set "Control for HDMI" to "OFF". When "Control for HDMI" is set to "OFF", the receiver detects the 24p signals by itself.

Using Multi-zone Features

What you can do with the Multi-zone function

You can enjoy images and sounds in zone 2 (other than the main zone) and sounds in zone 3 from a component connected to the receiver.

For example, you can watch the DVD in the main zone and listen to the CD in zone 2 or zone 3.

When using an IR repeater (not supplied), you can operate both a component in the main zone and Sony receiver in zone 2 or zone 3 from zone 2 or zone 3.

Use the multi function remote in zone 2 or zone 3. You cannot use the simple remote in a zone (zone 2 or zone 3) other than the main zone.

To operate the receiver from zone 2 or zone 3

You can operate the receiver without pointing the remote toward the remote sensor of the receiver if you connect an IR repeater (not supplied) to the IR REMOTE jack.

Use an IR repeater when you install the receiver in a place where signals from the remote cannot reach.

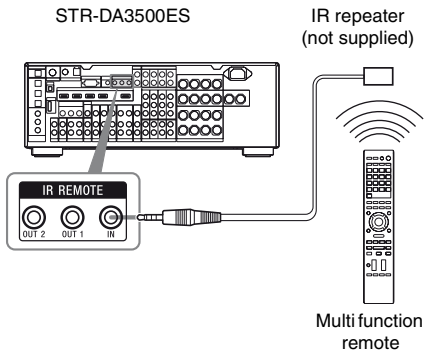

Making a multi-zone operation

1: Zone 2 connections

- ① Outputs sound from speakers in zone 2 using the **SPEAKERS SURROUND BACK** terminals of the receiver.

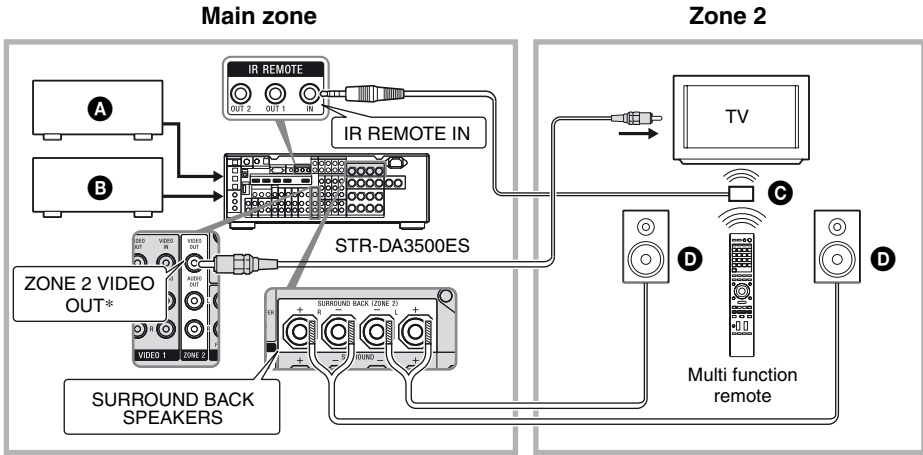

- ② Outputs sound from speakers in zone 2 using the receiver and another amplifier.

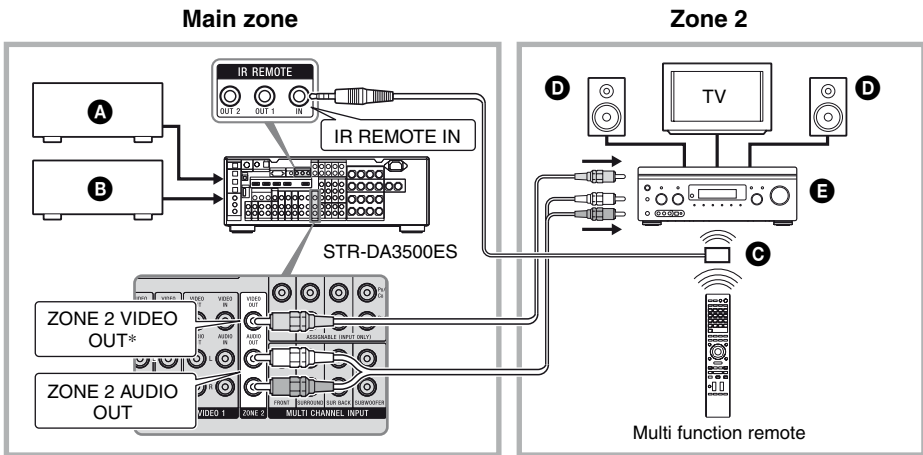

- A** Audio component
- B** Video component
- C** IR repeater (not supplied)
- D** Speakers
- E** Sony Amplifier/Receiver

* You can also connect to the COMPONENT VIDEO OUT (ZONE 2) jack.

2: Zone 3 connections

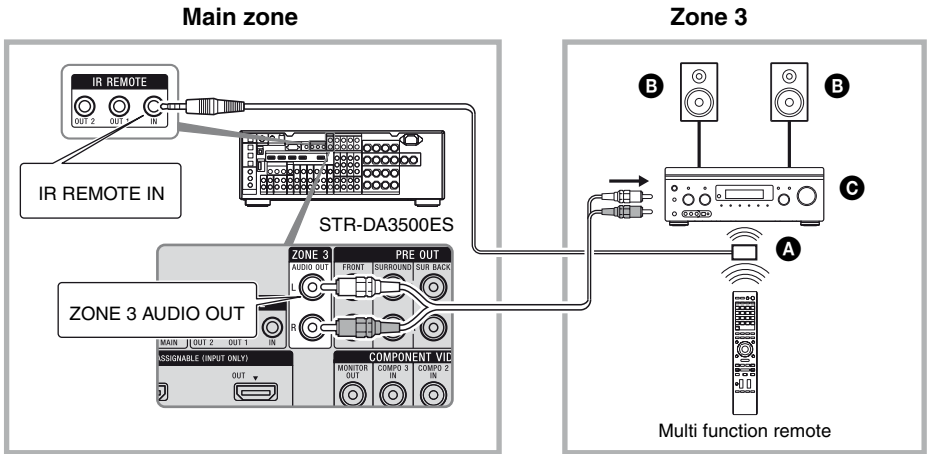

- A** IR repeater (not supplied)
- B** Speakers
- C** Sony Amplifier/Receiver

Setting the speakers in zone 2

When the speakers in zone 2 are connected to the SPEAKERS SURROUND BACK terminals of the receiver (page 91), make the setting so that the sound selected in zone 2 is output from the speakers connected to the SPEAKERS SURROUND BACK terminals.

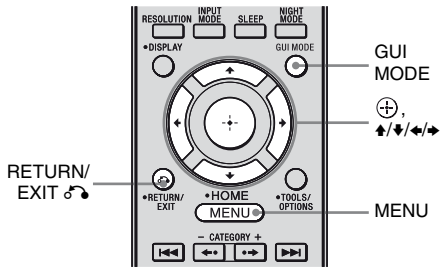

- 1** Press GUI MODE repeatedly to select “GUI ON”.
The GUI menu appears on the TV screen. Press MENU if the GUI menu does not appear on the TV screen.
- 2** Press \uparrow/\downarrow repeatedly to select “Settings”, then press \oplus or \rightarrow .
- 3** Press \uparrow/\downarrow repeatedly to select “Speaker”, then press \oplus or \rightarrow .
- 4** Press \uparrow/\downarrow to select “Speaker Pattern”, then press \oplus .
Select the speaker pattern that has no surround back speakers.
- 5** Press RETURN/EXIT \hookrightarrow .
- 6** Press \uparrow/\downarrow repeatedly to select “Sur Back Assign”, then press \oplus .
- 7** Press \uparrow/\downarrow repeatedly to select “ZONE2”, then press \oplus .

Setting audio/video output signals to the zone 2/zone 3

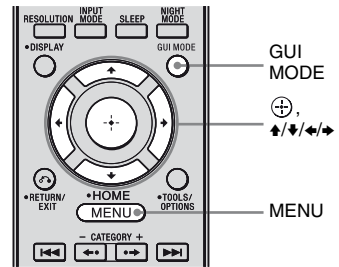

- 1** Press GUI MODE repeatedly to select “GUI ON”.
The GUI menu appears on the TV screen. Press MENU if the GUI menu does not appear on the TV screen.
- 2** Press \uparrow/\downarrow repeatedly to select “Settings”, then press \oplus or \rightarrow .
- 3** Press \uparrow/\downarrow repeatedly to select “Multi Zone”, then press \oplus .
- 4** Press \uparrow/\downarrow to select the zone to which you want to output audio/video signals, then press \oplus .
“Main” (this receiver) is always selected. If you do not change the setting, proceed to step 6.

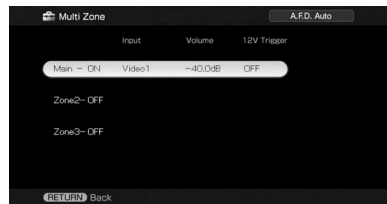

- 5** Press **▲/▼** to select “Zone2-ON”/“Zone3-ON” or “Zone2-OFF”/“Zone3-OFF”, then press **⊕**.

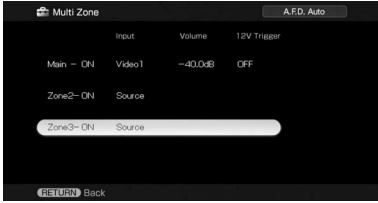

- 6** Press **▲/▼/◀/▶** repeatedly to select item and parameter, then press **⊕**.

Note

You can only enjoy the sound in zone 3.

Multi Zone menu parameters

■ Power

Lets you turn zone operation on.

- Zone2-ON or Zone3-ON
- Zone2-OFF or Zone3-OFF

■ Input

Lets you select the source that is output to the zone. You can output audio and video signals to zone 2 and only audio signals are output to zone 3.

■ Volume

You can adjust the volume in the main zone. If “Sur Back Assign” is set to “ZONE2” in the Speaker setting menu, you can also adjust the zone 2 volume.

■ 12V Trigger

You can turn the receiver on/off in another zone, or select various options for use of the 12V Trigger function, as explained below.

- OFF
Lets you turn off output of 12V triggers even when the main receiver is turned on.
- CTRL
Lets you turn the output of 12V triggers on or off manually using the CIS command of the external control device.
- ZONE
Lets you turn the output of 12V triggers on or off based on whether the selected zone is turned on or off.
- INPUT (for “Main” only)
Lets you turn on the output of 12V triggers when the preset input is selected. When you select “Input”, the setting display which sets each input trigger to on/off appears. Press **▲/▼** to select the input, then press **⊕** to check the box.

Note

You cannot select FM/AM/XM/SIRIUS/DMPOR in zone 3.

Tips

- Even when this receiver is in standby mode (press **I/⏻** on the remote to turned off this receiver), the receiver in zone 2 or zone 3 remains turned on. To turn off all receivers, press **I/⏻** and **AV I/⏻** on the multi function remote at the same time (SYSTEM STANDBY).
- Only signals from components connected to the analog input jacks are output through the ZONE 2 OUT or ZONE 3 OUT jacks. No signals are output from components connected to only the digital input jacks.
- When SOURCE is selected, the signals input to the MULTI CHANNEL INPUT jacks are not output from the ZONE 2 OUT or ZONE 3 OUT jacks even when the multi channel input is selected. The analog audio signals of the current function are output.

Switching the zone setting of the remote

The remote commander is initially set to be used in zone 2. If you want to use it in zone 3, switch the zone setting of the remote.

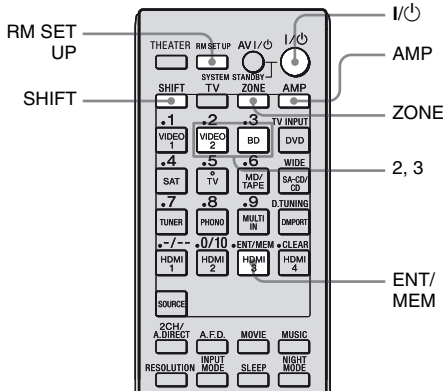

1 Press I/O while pressing RM SET UP.

The AMP and ZONE buttons flash.

2 Press ZONE.

The AMP button goes off, the ZONE button keeps flashing and the SHIFT button lights up.

3 Press the numeric button 2 for the zone 2, or 3 for the zone 3 while the ZONE button is flashing.

The ZONE button lights up.

4 Press ENT/MEM.

The ZONE button flashes twice and the remote switches to zone 2 or zone 3 mode.

Operating the receiver from another zone (ZONE 2/ZONE 3 operations)

For details on the connections and settings of zone 2 and zone 3, see “Using Multi-zone Features” (page 90).

The following operations are described for connecting an IR repeater and operating the receiver in zone 2 and zone 3. When an IR repeater is not connected, use this receiver in the main zone.

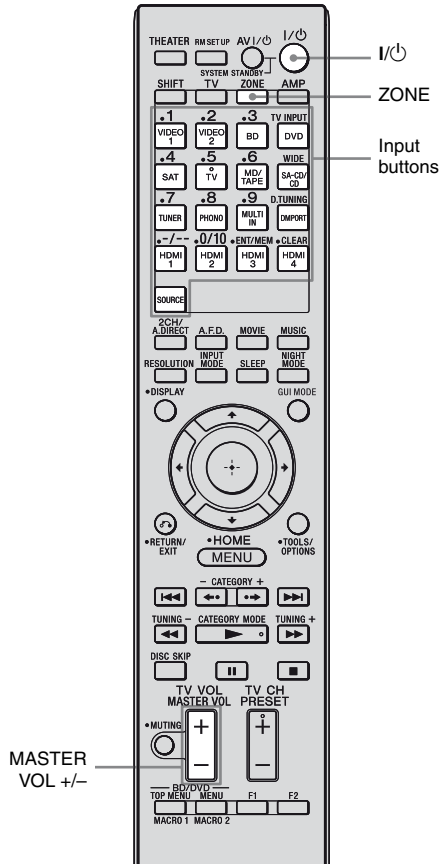

1 Turn on the main receiver (this receiver).

2 Press ZONE.

The remote switches to zone 2 or zone 3 mode.

Change the zone setting of the remote to zone 2 or zone 3 in advance (page 95).

3 Turn on the amplifier in zone 2 or zone 3.

4 Press one of the input buttons on the remote to select the source signals you want to output.

For zone 2, analog video and audio signals are output. For zone 3, only analog audio signals are output. When you select SOURCE, the signals of the current input are output.

5 Adjust to a suitable volume.

- In the case of illustration 1-① (page 91).
Adjust the volume using MASTER VOL +/- on the remote.
- In the case of illustration 1-② (page 91), adjust the volume using the receiver of zone 2.
- In case of illustration 2 (page 92), adjust the volume using the receiver of zone 3.

Tips

- Even when this receiver is in standby mode (press I/⏻ on the remote to turned off this receiver), the receiver in zone 2 and zone 3 remains turned on. To turn off all receivers, press I/⏻ and AV I/⏻ on the multi function remote at the same time (SYSTEM STANDBY).
- Only signals from components connected to the analog input jacks are output through the ZONE 2 OUT or ZONE 3 OUT jacks. No signals are output from components connected to only the digital input jacks. You cannot select some input according to the selected zone.
- When SOURCE is selected, the signals input to the MULTI CHANNEL INPUT jacks are not output from the ZONE 2 OUT or ZONE 3 OUT jacks even when the multi channel input is selected.

Other Operations

Converting analog video input signals

This receiver allows you to convert the resolution of analog video input signals.

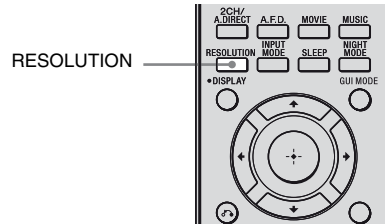

Press RESOLUTION repeatedly.

Each time you press the button, the resolution of the output signals will be changed.

You can also use “Resolution” in the Video settings menu.

Enjoying the sound/ images from the components connected to the DIGITAL MEDIA PORT

The DIGITAL MEDIA PORT is for enjoying sound/images from a portable audio/video source or computer by connecting a DIGITAL MEDIA PORT adapter.

For details on connecting the DIGITAL MEDIA PORT adapter, see “Connecting components with digital audio input/output jacks” (page 21).

Sony offers the following DIGITAL MEDIA PORT adapters:

- TDM-BT1/BT10 Bluetooth™ Wireless Audio Adapter
- TDM-NW10 DIGITAL MEDIA PORT Adapter
- TDM-NC1 Wireless Network Audio Client
- TDM-iP10/iP50 DIGITAL MEDIA PORT Adapter
- TDM-MP10 DIGITAL MEDIA PORT Adapter

The DIGITAL MEDIA PORT adapter is an optional product.

Notes

- Do not connect an adapter other than the DIGITAL MEDIA PORT adapter.
- Before disconnecting the DIGITAL MEDIA PORT adapter, make sure to turn the receiver off using the remote.
- Do not connect or disconnect the DIGITAL MEDIA PORT adapter to/from the receiver while the system is turned on.
- Depending on the type of DIGITAL MEDIA PORT adapter, the images are also output.
- The DIGITAL MEDIA PORT adapters are available for purchase depending on the area.

Selecting an operation screen to operate the component connected to the DIGITAL MEDIA PORT adapter

You can select an operation screen using the GUI menu, depending on the DIGITAL MEDIA PORT adapter you want to use. For some adapter, such as TDM-BT1, the operation screen is fixed and you cannot change it on the GUI screen.

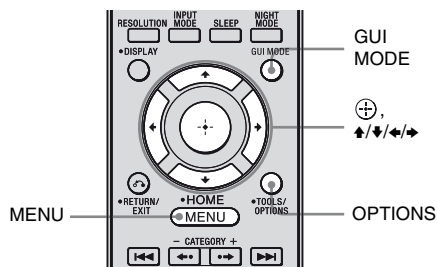

1 Press GUI MODE repeatedly to select “GUI ON”.

The GUI menu appears on the TV screen. Press MENU if the GUI menu does not appear on the TV screen.

2 Press \uparrow/\downarrow repeatedly to select “Music” or “Video”, then press \oplus or \ominus .

3 Press \oplus or \rightarrow .

The component connected to the DIGITAL MEDIA PORT adapter is recognized and “DMPORT” on the screen will change to the component’s name. The category of the component connected to DIGITAL MEDIA PORT adapter appears on the TV screen.

Note

An icon which shows the component recognized is displayed on the TV screen. If the component connected to the adapter cannot be recognized, “DMPORT” is displayed on the TV screen.

4 Press **OPTIONS** to display “Function List”.

5 Press **↑/↓** to select “DMPORT Control”, then press **⊕** or **➔**.

You can select the following modes in this menu:

- System GUI

This mode is for the TDM-iP50 and TDM-NC1. The list of tracks will be displayed on the GUI screen of the receiver. You can select a track you want and play it back on each GUI screen.

- Adapter GUI

This mode is for the TDM-iP50 and TDM-NC1. The menu of the adapter will be displayed on the TV screen.

- iPod

This mode can be selected only when the TDM-iP50 is connected.

If “DMPORT Control” is not displayed, refer to the operating instructions supplied with component for details on operating that component.

Operating the component connected to the DIGITAL MEDIA PORT adapter

To operate the TDM-iP50/TDM-NC1 using the GUI menu of the receiver

1 Make sure that “System GUI” is selected in step 5 in “Selecting an operation screen to operate the component connected to the DIGITAL MEDIA PORT adapter” (page 97).

2 Select the content from the contents list displayed on the GUI screen and play it back.

The following content lists are just examples. They may vary depending on the components connected to the receiver.

In case of iPod

Music

- Playlists > Playlist > Track
- Artists > Artist > Album > Track
- Albums > Album > Track
- Songs > Track
- Genres > Genre > Artist > Album > Track
- Composers > Composer > Album > Track
- Audiobooks > Track

Video

- Movies > Content
- TV Shows > Episode > Content
- Music Videos > Artist > Content
- Video Podcast > Episode > Content

In case of Network Client

Music

- Surfin^{a)} > Album^{c)} > Track
- Playlist^{a)} > Playlist > Track
- Web Radio^{a)} > Station > Program
- Music Library^{b)} > Album > Track

^{a)} Displayed only when M-crew Server is connected.

^{b)} Displayed only when a DLNA server other than M-crew Server is connected.

^{c)} Displayed as “Genre”, “Artist” or “Album”, depending on the “List Mode” setting.

To operate the TDM-iP50 or TDM-NC1 using the adapter menu

Make sure that “Adapter GUI” is selected in step 5 in “Selecting an operation screen to operate the component connected to the DIGITAL MEDIA PORT adapter” (page 97). For details on operating the adapter using the adapter GUI menu, refer to the operating instructions supplied with the adapter you are using.

To operate the TDM-iP50 using the iPod menu

Make sure that “iPod” is selected in step 5 in “Selecting an operation screen to operate the component connected to the DIGITAL MEDIA PORT adapter” (page 97).

For details on operating the iPod, refer to the operating instruction supplied with the iPod.

Playing back the track selected

During playback of the track selected, the displayed screen changes depending on the DIGITAL MEDIA PORT adapter connected.

TDM-iP50

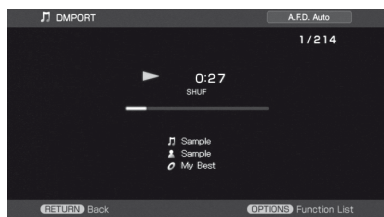

TDM-NC1



You can also operate the components connected to the DIGITAL MEDIA PORT adapter using the following play mode buttons on the remote of the receiver.

Press DMPORT on the remote to enable DMPORT operation.

To	Do the following
Play	Press ▶ .
Pause	Press ⏸ . To resume play, press the button again.
Stop	Press ■ .*
Find the beginning of a track during playback, or find the beginning of the previous track	Press ⏮ .
Find the beginning of the next track	Press ⏭ .
Skip to the previous album	Press ⏪ .
Skip to the next album	Press ⏩ .
Go backward/forward	Press ⏮/⏭ .*

* When a TDM-iP50 is connected, the receiver enters pause mode when **■** is pressed.

** Fast-backward/forward while pressing and holding the **⏮/⏭** button.

Option parameters in the play modes

■ Repeat Mode (TDM-iP50 only)

Plays one or all the track repeatedly.

- Off
Deactivates the repeat play mode.
- One
Plays one track repeatedly.
- All
Plays all the tracks repeatedly.

■ Shuffle (TDM-iP50 only)

Plays all the tracks in random order.

- Off
Deactivates the shuffle play mode.
- Albums
Plays all the tracks on an album in random order.
- Songs
Plays all the tracks in “Songs” in random order.

■ Audiobook Speed (TDM-iP50 only)

Selects the display speed of the Audiobook.

- Low
Slows the display speed.
- Normal
Sets the display speed to standard.
- High
Increases the display speed.

■ List Mode (TDM-NC1 only)

Selects a range of tracks to be played back.

- Genre
Plays back tracks in the selected genre.
- Artist
Plays back tracks of the selected artist.
- Album
Plays back tracks in the selected album.

Tip

The List Mode can be used with the Function List menu even when the list is displayed.

DIGITAL MEDIA PORT message list

Message appears	Explanation
No Adapter	The adapter is not connected.
No Device	There is no device connected to the adapter.
No Audio	No audio file was found.
Loading	The data is being read.
No Server*	There is no server connected.
No Track*	No track was found.
No Item*	No item was found.
Connecting*	Connecting to the server.
Configuring*	The network is setting up.
Warning*	Check the display of the DIGITAL MEDIA PORT adapter.
Party Mode*	The unit is currently in party mode “Guest”.
Searching*	Searching the server.

* TDM-NC1 only.

Naming inputs

You can enter a name of up to 8 characters for inputs and display it.

This is convenient for labeling the jacks with the names of the connected components.

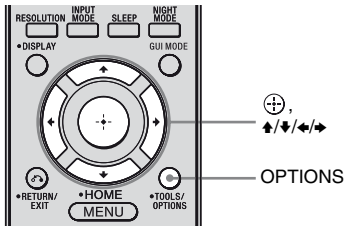

1 Choose the item you want to name.

You can name the following items.

- Auto Calibration position (page 50)
- Inputs (page 50)
- Preset stations (page 73)

2 Press OPTIONS.

3 Select “Name Input”, then press .

The soft keyboard appears on the screen.

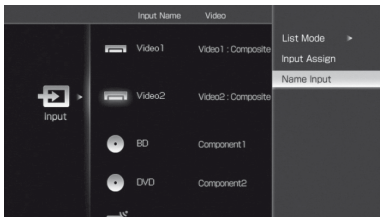

4 Press to select a character, then press .

5 Select [Finish] to enter the name.

The name you entered is registered.

To cancel naming input

Select [Cancel].

Switching between digital and analog audio (INPUT MODE)

When you connect components to both digital and analog audio input jacks on the receiver, you can fix the audio input mode to either of them, or switch from one to the other, depending on the type of material you intend to watch.

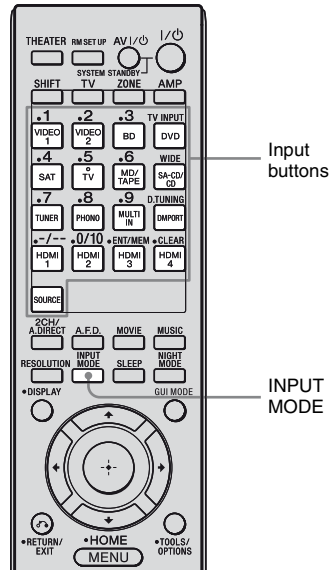

1 Press the input button.

You can also use INPUT SELECTOR on the receiver.

2 Press INPUT MODE repeatedly to select the audio input mode.

The selected audio input mode appears on the TV screen.

Audio input modes

- **AUTO**
Gives priority to digital audio signals when there are both digital and analog connections.
If there are more than one digital connection, HDMI audio signals have priority over COAXIAL and OPTICAL audio signals.
If there are no digital audio signals, analog audio signals are selected.
- **ANALOG**
Specifies the analog audio signals input to the AUDIO IN (L/R) jacks.

Notes

- Some audio input modes may not be set up depending on the input.
- When HDMI input, XM, SIRIUS or DMPORT is selected, “-----” appears on the display window, and you cannot select other audio input modes. Select an input other than the HDMI input, XM, SIRIUS and DMPORT input then set the audio input mode.
- When “2ch Analog Direct” is being used, or the multi channel input is selected, audio input mode is set to “ANALOG”. You cannot select other audio input modes.

Enjoying the sound/ images from other inputs

You can reassign video and/or audio signals to another input.

Example: Connect the OPTICAL OUT jack of the DVD player to the OPTICAL VIDEO 1 IN jack of this receiver when you want to input the only digital optical audio signals from the DVD player.

Connect the component video jack of the DVD player to the COMPONENT VIDEO COMPO 1 IN jack of this receiver when you want to input the video signals from the DVD player. Assign video and/or audio signals to the DVD input jack using “Input Assign” in the Input menu.

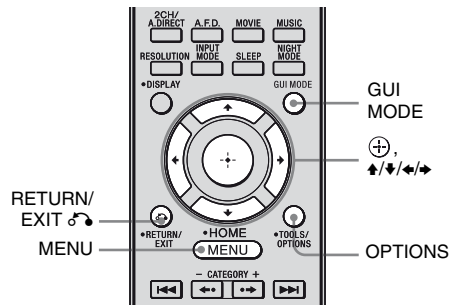

1 Press GUI MODE repeatedly to select “GUI ON”.

The GUI menu appears on the TV screen. Press MENU if the GUI menu does not appear on the TV screen.

- 2** Press \uparrow/\downarrow repeatedly to select “Input”, then press \oplus or \rightarrow .



- 3** Press \uparrow/\downarrow to select the input name you want to assign.
- 4** Press **OPTIONS**, then select “Input Assign” and then press \oplus .

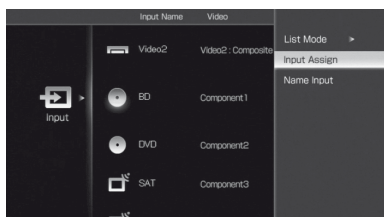

- 5** Select the audio and/or video signals you want to assign to the input which you selected in step 3 using $\uparrow/\downarrow/\leftarrow/\rightarrow$, then press \oplus .

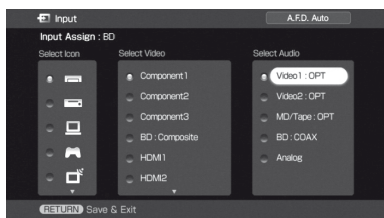

- 6** Press **RETURN/EXIT** \rightarrow to enter the setting.

Input name		VIDEO1	VIDEO2	BD	DVD	SAT	MD/TAPE	SA-CD/ CD	MULTI IN
Assignable video input jacks	Video1: Composite	○	-	-	-	-	-	-	-
	Video2: Composite	-	○	-	-	-	-	-	-
	BD: Composite	-	-	○	-	-	-	-	-
	DVD: Composite	-	-	-	○	-	-	-	-
	SAT: Composite	-	-	-	-	○	-	-	-
	HDMI1	○	○	○	○	○	○	○	○
	HDMI2	○	○	○	○	○	○	○	○
	HDMI3	○	○	○	○	○	○	○	○
	HDMI4	○	○	○	○	○	○	○	○
	Component1	○	○	○	○	○	○	○	○
	Component2	○	○	○	○	○	○	○	○
	Component3	○	○	○	○	○	○	○	○
None	○	○	○	○	○	○	○	○	
Assignable audio input jacks	Video1: OPT	○	-	○	○	○	-	○	-
	Video2: OPT	-	○	○	○	○	-	○	-
	MD/TAPE: OPT	-	-	○	○	○	○	○	-
	BD: COAX	○	○	○	-	○	○	-	-
	DVD: COAX	○	○	-	○	○	○	-	-
	SA-CD/CD: COAX	○	○	-	-	○	○	○	-
	Analog	○	○	○	○	○	○	○	-

Notes

- You cannot assign optical signals from an input source to the optical input jacks on the receiver, and you cannot assign coaxial signals from the input source to the coaxial input jacks on the receiver.
- When you assign the digital audio input, the INPUT MODE setting may change automatically.

Changing the display window

You can check the sound field, etc., by changing the information on the display window.

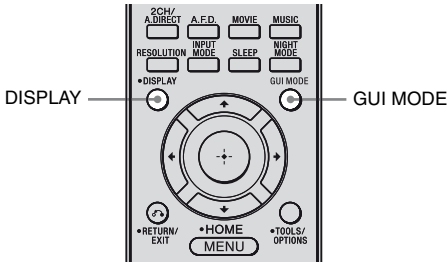

XM Radio and SIRIUS Satellite Radio

Channel name → Channel number →
 Category name → Artist name/Feature →
 Song/Program title → Composer name
 (SIRIUS only) → Signal strength →
 Sound field type → Volume level

* Index name appears only when you have assigned one to the input or preset station. Index name does not appear when only blank spaces have been entered.

Note

Character or marks may not be displayed for some languages.

Press DISPLAY repeatedly.

Each time you press DISPLAY, the display will change as follows.

Input name you selected* → Original input name → Sound field type → Volume level

Tip

If you see “GUI MODE” on the display window when you press DISPLAY, press GUI MODE repeatedly to select “GUI OFF”.

FM and AM band

Station name* → Frequency → Sound field type → Volume level

About the indicators on the display window

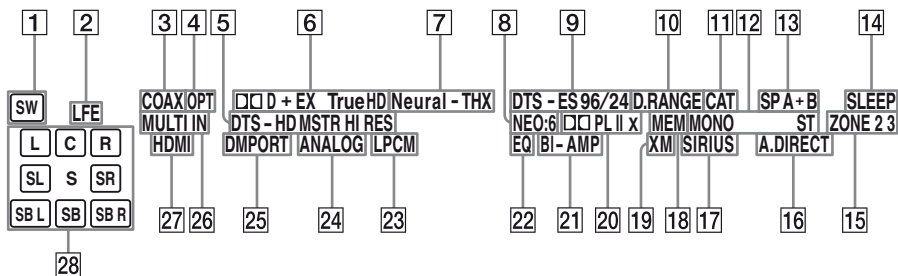

Name	Function
1 SW	Lights up when subwoofer is connected and the audio signal is output from the SUBWOOFER jack. While this indicator lights up, the receiver creates a subwoofer signal based on the LFE signal in the disc being played back or the low frequency components of the front channels.
2 LFE	Lights up when the disc being played back contains an LFE (Low Frequency Effect) channel and the LFE channel signal is actually being reproduced.
3 COAX	Lights up when INPUT MODE is set to "AUTO" and the source input is a digital signal being input through the COAXIAL jack.
4 OPT	Lights up when INPUT MODE is set to "AUTO" and the source signal is a digital signal being input through the OPTICAL jack.
5 DTS-HD MSTR/ DTS-HD HI RES	"DTS-HD MSTR" lights up when the receiver is decoding DTS-HD Master Audio signals. "DTS-HD HI RES" lights up when the receiver is decoding DTS-HD High Resolution signals.
6 D/ D EX/ D+/ TrueHD	"D" lights up when the receiver is decoding Dolby Digital signals. "D EX" lights up when the receiver is decoding Dolby Digital Surround EX signals. "D+" lights up when the receiver is decoding Dolby Digital Plus signals. "TrueHD" lights up when the receiver is decoding Dolby TrueHD signals. Note When playing a Dolby Digital format disc, be sure that you have made digital connections and that INPUT MODE is set to "AUTO" (page 101).
7 Neural - THX	Lights up when the receiver applies Neural - THX processing to input signals.
8 NEO:6	Lights up when DTS Neo:6 Cinema/Music decoder is activated.
9 DTS/ DTS-ES/ DTS 96/24	"DTS" lights up when the receiver is decoding DTS signals. "DTS-ES" lights up when the receiver is decoding DTS-ES signals. "DTS 96/24" lights up when the receiver is decoding DTS 96 kHz/24 bit signals. Note When playing a DTS format disc, be sure that you have made digital connections and that INPUT MODE is set to "AUTO" (page 101).

Name	Function
10 D.RANGE	Lights up when dynamic range compression is activated.
11 CAT	Lights up when category mode is selected during the satellite radio operation.
12 Tuner indicators	Lights up when using the receiver to tune in radio stations, etc.
13 SP A/SP B/ SP A+B	Lights up according to the speaker system used (page 44). However, these indicators do not light up if the speaker output is turned off or if headphones are connected.
14 SLEEP	Lights up when the sleep timer is activated.
15 ZONE 2/ ZONE 3	Lights up while operation in zone 2/zone 3 is being enabled.
16 A.DIRECT	Lights up when the receiver is processing Analog Direct signals.
17 SIRIUS	Lights up when the SiriusConnect Home tuner is connected and "SIRIUS" is selected.
18 MEM	Lights up when a memory function, such as Preset Memory, etc., is activated.
19 XM	Lights up when XM Mini Tuner and Home Dock are connected and "XM RADIO" is selected.
20 PL/ PL II/ PL IIX	<p>"PL" lights up when the receiver applies Dolby Pro Logic processing to 2 channel signals in order to output the center and surround channel signals.</p> <p>"PL II" lights up when the Dolby Pro Logic II decoder is activated.</p> <p>"PL IIX" lights up when the Dolby Pro Logic IIX decoder is activated.</p> <p>However, these indicators do not light up if there are no center and surround speakers and you select a sound field using the A.F.D. button.</p>

Name	Function
21 BI-AMP	Lights up when "Sur Back Assign" is set to "BI-AMP".
22 EQ	Lights up when the equalizer is activated.
23 LPCM	Lights up when Linear PCM signals are detected.
24 ANALOG	<p>Lights up when</p> <ul style="list-style-type: none"> - INPUT MODE is set to "AUTO" and no digital signal is being input through the COAXIAL, OPTICAL or HDMI jacks. - INPUT MODE is set to "ANALOG". - the "2ch Analog Direct" is being used.
25 DMPORT	Lights up when DIGITAL MEDIA PORT adapter is connected and "DMPORT" is selected.
26 MULTI IN	Lights up when multi channel input is selected.
27 HDMI	Lights up when the receiver recognizes a component connected via an HDMI IN jack.

Name	Function
28 Playback channel indicators	The letters (L, C, R, etc.) indicate the channels being played back. The boxes around the letters vary to show how the receiver downmixes the source sound (based on the speaker settings).
L	Front Left
R	Front Right
C	Center (monaural)
SL	Surround Left
SR	Surround Right
S	Surround (monaural or the surround components obtained by Pro Logic processing)
SB L	Surround Back Left
SB R	Surround Back Right
SB	Surround Back (the surround back components obtained by 6.1 channel decoding)
Example:	Recording format (Front/Surround): 3/2.1 When Speaker Pattern is set to "3/0.1" (page 114) Sound Field: A.F.D. AUTO

Using the sleep timer

You can set the receiver to turn off automatically at a specified time.

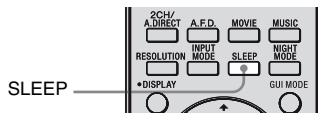

Press SLEEP repeatedly.

Each time you press SLEEP, the display changes cyclically as follows:

0:30:00 → 1:00:00 → 1:30:00 → 2:00:00
→ OFF

When sleep timer is being used, "SLEEP" lights up in the display window.

Tip

To check the remaining time before the receiver turns off, press SLEEP. The remaining time appears on the display window. If you press SLEEP again, the sleep timer will be cancelled.

Recording using the receiver

You can record from a video/audio component using the receiver. Refer to the operating instructions supplied with your recording component.

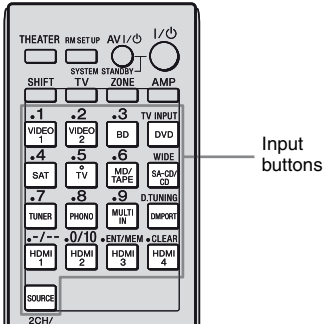

Recording onto a MiniDisc or audio tape

You can record onto a MiniDisc or audio tape using the receiver. Refer to the operating instructions supplied with your MD deck or tape deck.

1 Press the input button of the playback component.

You can also use INPUT SELECTOR on the receiver.

2 Prepare the playback component for playing.

For example, insert a CD into the CD player.

3 Prepare the recording component.

Insert a blank MD or tape into the recording deck and adjust the recording level.

4 Start recording on the recording deck, then start playback on the playback component.

Notes

- Sound adjustments do not affect the signal output from the MD/TAPE OUT jacks.
- The audio input signals from the MULTI CHANNEL INPUT jacks are not output.

To record digital sound

Connect a component for playback to the digital audio input (OPTICAL IN) jack, and connect the recording component to the OPTICAL MD/TAPE OUT jack.

Recording onto a recording media

1 Press the input button of the playback component.

You can also use INPUT SELECTOR on the receiver.

2 Prepare the component for playing.

For example, insert the video tape you want to copy into the VCR.

3 Prepare the recording component.

Insert a blank video tape, etc., into the recording component (VIDEO 1) for recording.

4 Start recording on the recording component, then start playback on the playback component.

Notes

- Some sources contain copy guards to prevent recording. In this case, you may not be able to record from the sources.
- The audio input signals from the MULTI CHANNEL INPUT jacks are not output.
- Only analog input signals are output from the analog output jack (for recording).
- Only digital input signals are output from the digital output jack (for recording).
- HDMI sound cannot be recorded.

Using a bi-amplifier connection

If you are not using the surround back speakers, you can use the SPEAKERS SURROUND BACK terminals for the front speakers in a bi-amplifier connection.

To connect the speakers

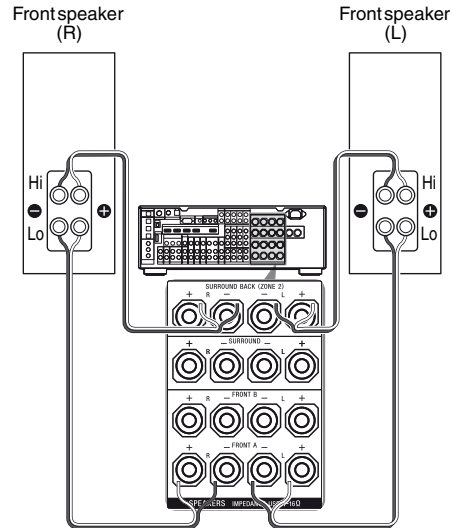

Connect the jacks on the Lo (or Hi) side of the front speakers to the SPEAKERS FRONT A terminals, and connect the jacks on the Hi (or Lo) side of the surround speakers to the SPEAKERS SURROUND BACK terminals. Make sure that the metal fittings of Hi/Lo attached to the speakers have been removed from the speakers. Otherwise, it may cause the receiver to malfunction.

To set up the speakers

Set “Sur Back Assign” to “BI-AMP” in the Speaker settings menu. The same signals output from the SPEAKERS FRONT A terminals can be output from the SPEAKERS SURROUND BACK terminals by setting “Sur Back Assign” to “BI-AMP”.

Notes

- You cannot use the SPEAKERS FRONT B terminals for a bi-amplifier connection.
- Set “Sur Back Assign” to “BI-AMP” before you perform Auto Calibration.
- If you set “Sur Back Assign” to “BI-AMP”, the speaker level, balance, and equalizer settings of the surround back speakers become invalid, and those of the front speakers are used.
- Signals output from the PRE OUT jacks are used with the same settings as those of the SPEAKERS terminals.
- If you set “Speaker Pattern” to a setting with surround back speakers, you cannot set “Sur Back Assign” to “BI-AMP”.

Operating without connecting to the TV

You can operate this receiver using the display window if you do not use a GUI when a TV is not connected.

Press GUI MODE to display “GUI OFF” in the display window.

When “GUI MODE” is displayed in the display window, the menu is set to display on the TV screen using a GUI.

Navigating through menus on the display window

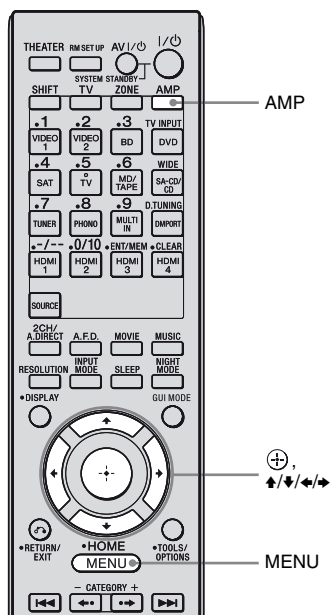

- 1 Press AMP.
- 2 Press MENU.
- 3 Press \uparrow/\downarrow repeatedly to select the menu you want.

- 4** Press \oplus or \rightarrow to enter the menu.
- 5** Press \uparrow/\downarrow repeatedly to select the parameter you want to adjust.
- 6** Press \oplus or \rightarrow to enter the parameter.
- 7** Press \uparrow/\downarrow repeatedly to select the setting you want.
- 8** Press \oplus to enter the setting.

To return to the previous display

Press \leftarrow .

To exit the menu

Press MENU.

Note

Some parameters and settings may dimmed on the display window. This means that they are either unavailable or fixed and unchangeable.

Overview of the menus

The following options are available in each menu. For details on navigating through menus, see page 41.

Menu [Display window]	Parameters [Display window]	Settings	Initial Setting
Auto Calibration [<AUTO CAL>]	Auto Calibration start [A.CAL START]		
	Calibration type [CAL TYPE]	FULL FLAT, ENGINEER, FRONT REF, OFF	FULL FLAT
	Position [POSITION]	POS 3, POS 2, POS 1	POS 1
	Naming Inputs [NAME IN]	For details, see “Naming inputs” (page 101).	
Level Settings [<LEVEL>]	Test tone [TEST TONE]	OFF, FIX ■■■■ ^{a)} , AUTO ■■■■ ^{a)}	OFF
	Phase noise [P. NOISE]	OFF, FL/FR, FL/SR, SL/FL, SB/SL, SBL/SL, SBR/SBL, SR/SB, SR/SBR, SR/SL, FR/SR, FR/SL, CNT/FR, FL/CNT	OFF
	Phase audio [P. AUDIO]	OFF, FL/FR, FL/SR, SL/FL, SB/SL, SBL/SL, SBR/SBL, SR/SB, SR/SBR, SR/SL, FR/SR, FR/SL, CNT/FR, FL/CNT	OFF
	Front left speaker level [FL LEVEL]	FL -10.0 dB to FL +10.0 dB (0.5 dB step)	FL 0 dB
	Front right speaker level [FR LEVEL]	FR -10.0 dB to FR +10.0 dB (0.5 dB step)	FR 0 dB
	Center speaker level [CNT LEVEL]	CNT -20.0 dB to CNT +10.0 dB (0.5 dB step)	CNT 0 dB
	Surround left speaker level [SL LEVEL]	SL -20.0 dB to SL +10.0 dB (0.5 dB step)	SL 0 dB
	Surround right speaker level [SR LEVEL]	SR -20.0 dB to SR +10.0 dB (0.5 dB step)	SR 0 dB
	Surround back speaker level ^{b)} [SB LEVEL]	SB -20.0 dB to SB +10.0 dB (0.5 dB step)	SB 0 dB
	Surround back left speaker level ^{c)} [SBL LEVEL]	SBL -20.0 dB to SBL +10.0 dB (0.5 dB step)	SBL 0 dB
	Surround back right speaker level ^{c)} [SBR LEVEL]	SBR -20.0 dB to SBR +10.0 dB (0.5 dB step)	SBR 0 dB
	Subwoofer level [SW LEVEL]	SW -20.0 dB to SW +10.0 dB (0.5 dB step)	SW 0 dB
	Dynamic range compressor [D. RANGE]	COMP. MAX, COMP. STD, COMP. AUTO, COMP. OFF	COMP. AUTO

Menu [Display window]	Parameters [Display window]	Settings	Initial Setting
Speaker Settings [<SPEAKER>]	Speaker pattern [SP PATTERN]	3/4.1, 3/4, 3/3.1, 3/3, 2/4.1, 2/4, 3/2.1, 3/2, 2/3.1, 2/3, 2/2.1, 2/2, 3/0.1, 3/0, 2/0.1, 2/0	3/4.1
	Front speakers [FRT SIZE]	LARGE, SMALL	LARGE
	Center speaker [CNT SIZE]	LARGE, SMALL	LARGE
	Surround speakers [SUR SIZE]	LARGE, SMALL	LARGE
	Surround Back Speaker Assign [SB ASSIGN]	ZONE2, BI-AMP, OFF	OFF
	Front left speaker distance [FL DIST.]	FL 3'3" to FL 32'9" (FL 1.00 m to FL 10.00 m) (1 inch (0.01 m) step)	FL 9'10" (3.00 m)
	Front right speaker distance [FR DIST.]	FR 3'3" to FR 32'9" (FR 1.00 m to FR 10.00 m) (1 inch (0.01 m) step)	FR 9'10" (3.00 m)
	Center speaker distance [CNT DIST.]	CNT 3'3" to CNT 32'9" (CNT 1.00 m to to CNT 10.00 m) (1 inch (0.01 m) step)	CNT 9'10" (3.00 m)
	Surround left speaker distance [SL DIST.]	SL 3'3" to SL 32'9" (SL 1.00 m to SL 10.00 m) (1 inch (0.01 m) step)	SL 9'10" (3.00 m)
	Surround right speaker distance [SR DIST.]	SR 3'3" to SR 32'9" (SR 1.00 m to SR 10.00 m) (1 inch (0.01 m) step)	SR 9'10" (3.00 m)
	Surround back speaker distance [SB DIST.]	SB 3'3" to SB 32'9" (SB 1.00 m to SB 10.00 m) (1 inch (0.01 m) step)	SB 9'10" (3.00 m)
	Surround back left speaker distance [SBL DIST.]	SBL 3'3" to SBL 32'9" (SBL 1.00 m to SBL 10.00 m) (1 inch (0.01 m) step)	SBL 9'10" (3.00 m)
	Surround back right speaker distance [SBR DIST.]	SBR 3'3" to SBR 32'9" (SBR 1.00 m to to SBR 10.00 m) (1 inch (0.01 m) step)	SBR 9'10" (3.00 m)
	Subwoofer distance [SW DIST.]	SW 3'3" to SW 32'9" (SW 1.00 m to SW 10.00 m) (1 inch (0.01 m) step)	SW 9'10" (3.00 m)
	Distance unit [DIST. UNIT]	FEET, METER	FEET
	Front speakers crossover frequency ^{b)} [FRT CROSS]	CROSS 40 Hz to CROSS 200 Hz	CROSS 120 Hz
	Center speaker crossover frequency ^{b)} [CNT CROSS]	CROSS 40 Hz to CROSS 200 Hz	CROSS 120 Hz
	Surround speakers crossover frequency ^{b)} [SUR CROSS]	CROSS 40 Hz to CROSS 200 Hz	CROSS 120 Hz
	Speaker Impedance [SP IMP.]	8 ohms, 4 ohms	8 ohms

Menu [Display window]	Parameters [Display window]	Settings	Initial Setting
Surround Settings [<SURROUND>]	Sound field selection [S.F. SELECT]	For details, see “Enjoying Surround Sound” (page 59).	
	Enhanced Surround mode [E.SUR MODE]	PLIIX ^{c)} , PLIIX ^{e)} , NEO6 CIN, NEO6 MUS, NEURAL-THX	PLIIX
	Effect Type [EFFECT]	DYNAMIC, THEATER, STUDIO	THEATER
EQ Settings [<EQ>]	Front speakers bass level [FRT BASS]	FRT B. -10 dB to FRT B. +10 dB (1 dB step)	FRT B. 0 dB
	Front speakers treble level [FRT TREBLE]	FRT T. -10 dB to FRT T. +10 dB (1 dB step)	FRT T. 0 dB
	Center speaker bass level [CNT BASS]	CNT B. -10 dB to CNT B. +10 dB (1 dB step)	CNT B. 0 dB
	Center speaker treble level [CNT TREBLE]	CNT T. -10 dB to CNT T. +10 dB (1 dB step)	CNT T. 0 dB
	Surround speakers bass level [SUR BASS]	SUR B. -10 dB to SUR B. +10 dB (1 dB step)	SUR B. 0 dB
	Surround speakers treble level [SUR TREBLE]	SUR T. -10 dB to SUR T. +10 dB (1 dB step)	SUR T. 0 dB
Tuner Settings [<TUNER>]	FM station receiving mode [FM MODE]	STEREO, MONO	STEREO
	Naming preset stations [NAME IN]	For details, see “To name preset stations” (page 74).	
	XM antenna aiming mode ^{c)} [XM ANT AIM]	For details, see “Aiming the XM Radio or SIRIUS antenna” (page 76).	
	XM radio ID ^{c)} [XM ID]	For details, see “Checking the XM Radio ID or SIRIUS ID number” (page 76).	
	Parental lock ^{d)} [PARENTAL]	OFF, ON	OFF
	Lock code edit ^{d)} [CODE EDIT]	For details, see “Restricting access to specific channels (Parental Lock) (SIRIUS only)” (page 80).	
	Sirius antenna aiming mode ^{d)} [SR ANT AIM]	For details, see “Aiming the XM Radio or SIRIUS antenna” (page 76).	
	Sirius radio ID ^{d)} [SIRIUS ID]	For details, see “Checking the XM Radio ID or SIRIUS ID number” (page 76).	

Menu [Display window]	Parameters [Display window]	Settings	Initial Setting
Audio Settings [<AUDIO>]	Synchronizes audio with video output [A/V SYNC]	0 to 300 ms (10 ms step)	0 ms
	Digital broadcast language selection [DUAL MONO]	MAIN/SUB, MAIN, SUB	MAIN
	Digital audio input decoding priority [DEC. PRIO]	DEC. AUTO, DEC. PCM	DEC. AUTO
	Audio input assignment [A. ASSIGN]	For details, see “Enjoying the sound/images from other inputs” (page 102).	
Video Settings [<VIDEO>]	Video signals conversion [RESOLUTION]	DIRECT, AUTO, 480/576i, 480/576p, 720p, 1080i, 1080p	AUTO
	Video input assignment [V. ASSIGN]	For details, see “Enjoying the sound/images from other inputs” (page 102).	
HDMI Settings [<HDMI>]	Control for HDMI [CTRL: HDMI]	CTRL ON, CTRL OFF	CTRL OFF
	HDMI audio input setting [AUDIO OUT]	AMP, TV+AMP	AMP
	24p Auto Sound Sync [24p SYNC]	ON, OFF	ON
	Subwoofer level for HDMI [SW LEVEL]	SW AUTO, SW +10 dB, SW 0 dB	SW AUTO
System Settings [<SYSTEM>]	Naming inputs [NAME IN]	For details, see “Naming inputs” (page 101).	
	Brightness of the display window [DIMMER]	100% DOWN, 60% DOWN, 0% DOWN	0% DOWN
	12V Trigger [12V TRIG.]	INPUT, ZONE, CTRL, OFF	OFF
	Installer Mode [INSTALLER]	RS232C, OFF	OFF

a) ■■■ represent a speaker channel (FL, FR, CNT, SL, SR, SB, SBL, SBR, SW).

b) You cannot select this setting if your speaker is set to “LARGE”.

c) This parameter is only available if the XM Mini-Tuner and Home Dock is connected to the XM jack on the receiver

d) This parameter is only available if the SiriusConnect Home tuner is connected to the SIRIUS jack on the receiver.

e) Depending on the speaker pattern setting, the appropriate Enhanced Surround mode appears.

Performing Auto Calibration

For details on the Auto Calibration, see “9: Calibrating the appropriate speaker settings automatically (Auto Calibration)” (page 44). See “Before you perform the Auto Calibration” (page 45) before performing the Auto Calibration.

To operate on the receiver

- 1 Press GUI MODE repeatedly to select “GUI OFF”.
- 2 Press AMP.
Receiver operation is enabled.
- 3 Press MENU.
- 4 Press \uparrow/\downarrow repeatedly to select “<AUTO CAL>”, then press \oplus .
- 5 Press \uparrow/\downarrow repeatedly to select “A.CAL START”, then press \oplus to start the measurement.
Measurement starts in five seconds. A count down is displayed.

Note

While the time is counting down, stand away from the measurement area to avoid measurement error.

- 6 Measurement starts.
The measurement process will take approximately 30 seconds. Wait until the measurement process completes.

To cancel Auto Calibration

The measurement will be canceled when you do the following:

- Press I/⏻, input buttons or MUTING.
- Press SPEAKERS (OFF/A/B/A+B) on the receiver.
- Change the volume level.
- Connect the headphones.
- Press GUI MODE.

Tips

- Operations other than turning the receiver on or off are deactivated during Auto Calibration.
- In the following situations, the measurements may not be performed correctly or Auto Calibration cannot be performed.
 - when special speakers, such as dipole speakers are connected.
 - when the multi zone function is used in zone 2/ zone 3.

To confirm/save Auto Calibration when GUI function is turned off

- 1 Confirm the measurement result.
When the measurement ends, a beep sounds and the measurement result appears on the display window.

Measurement result	Display window	Explanation
When the measurement process completes properly	COMPLETE	Proceed to step 2.
When the measurement process fails	E- ■■■■■■	See “Message list after Auto Calibration measurement” (page 49).

2 Press $\blacktriangle/\blacktriangledown$ repeatedly to select the item, then press \oplus .

Item	Explanation
RETRY	Performs the Auto Calibration again.
SAVE EXIT	Saves the measurement results and exits the setting process.
WARN CHECK	Displays a warning concerning the measurement results. See “Message list after Auto Calibration measurement” (page 49).
PHASE INFO.	Displays the phase of each speaker (in phase/out of phase). See “When you select “PHASE INFO.”” (page 118).
DIST. INFO.	Displays the measurement result for speaker distance.
LEVEL INFO.	Displays the measurement result for speaker level.
EXIT	Exits the setting process without saving the measurement results.

3 Select “SAVE EXIT” in step 2. The measurement results are saved.

4 Press $\blacktriangle/\blacktriangledown$ repeatedly to select the Auto Calibration type, then press \oplus .

Auto Calibration type	Explanation
FULL FLAT	Makes the measurement of frequency from each speaker flat.
ENGINEER	Sets the frequency characteristics to a set that matches that of the Sony listening room standard.
FRONT REF	Adjusts the characteristics of all the speakers to match the characteristics of the front speaker.
OFF	Set the Auto Calibration EQ to off.

Tip

The size of a speaker (LARGE/SMALL) is determined by the low frequency characteristics. The measurement results may vary, depending on the position of the optimizer microphone and speakers, and the shape of the room. It is recommended that you follow the measurement results. However, you can change those settings in the Speaker settings menu. Save the measurement results first, then try to change the settings if you want.

When you select “PHASE INFO.”

You can check the phase of each speaker (in phase/out of phase).

Press $\blacktriangle/\blacktriangledown$ repeatedly to select a speaker, then press \oplus to return to step 2 in “To confirm/save Auto Calibration when GUI function is turned off”.

Display window	Explanation
■■■*: IN	The speaker is in phase.
■■■*: OUT	The speaker is out of phase. The “+” and “-” terminals of the speaker may be connected the other way around. However, depending on the speakers, “OUT” appears on the display window even though the speakers are connected properly. This is because of the speakers’ specifications. In this case, you can continue to use the receiver.
■■■* ---	No speakers are connected.

* ■■■ represent a speaker channel.

FL	Front Left
FR	Front Right
CNT	Center
SL	Surround Left
SR	Surround Right
SB	Surround Back
SBL	Surround Back Left
SBR	Surround Back Right
SW	Subwoofer

Tip

Depending on the position of the subwoofer, the measurement results for polarity may vary. However, there will be no problems even if you continue to use the receiver with that value.

Selecting a sound field type

For details on each sound field type, see “Enjoying a pre-programmed sound field” (page 59).

Press 2CH/A.DIRECT, A.F.D., MOVIE (or MOVIE (HD-D.C.S.) on the receiver), or MUSIC repeatedly.

The selected sound field type appears on the display window.

To select the Enhanced Surround mode

- 1 Press AMP.
- 2 Press MENU.
- 3 Press \uparrow/\downarrow repeatedly to select “<SURROUND>”, then press \oplus or \rightarrow .
- 4 Press \uparrow/\downarrow repeatedly to select “E.SUR MODE”, then press \oplus or \rightarrow .
- 5 Press \uparrow/\downarrow repeatedly to select the Enhanced Surround mode you want, then press \oplus .

Note

The selected Enhanced Surround mode can only be applied if you have selected “E.SURROUND” by pressing A.F.D. repeatedly.

Listening to the sound without any adjustment (ANALOG DIRECT)

Press 2CH/A.DIRECT repeatedly to select “A. DIRECT”.

Listening to the FM/AM radio

For details on the tuner function, see “Tuner Operations” (page 71).

Tuning radio stations

- 1 Press TUNER repeatedly to select the FM or AM band.
You can also use INPUT SELECTOR on the receiver.
- 2 Press TUNING + or TUNING –.
Press TUNING + to scan from low to high frequencies, press TUNING – to scan from high to low frequencies. The receiver stops scanning whenever a station is received.
You can also press TUNING MODE on the receiver to select “AUTO”, and then turn TUNING +/- to select the stations.

Selecting a frequency directly (Direct Tuning)

- 1 After selecting the FM or AM band, press SHIFT and then press D.TUNING.
- 2 Press the numeric buttons to enter the frequencies, then press \oplus to enter.

Presetting radio stations

1 Tune in the station that you want to preset.

For details on the operation, see “Tuning radio stations” (page 119).

2 Press SHIFT and then press ENT/MEM.

“MEM” lights up on the display window for a few seconds. Perform steps 3 and 4 before “MEM” disappears.

3 Press PRESET + or PRESET – to select a preset number.

30 FM and 30 AM preset numbers are available. If “MEM” lights off before you select the preset number, start again from step 2.

4 Press ENT/MEM.

If SHIFT indicator is light off before you press ENT/MEM, press SHIFT. The station is stored as the selected preset number. If “MEM” disappears before you press ENT/MEM, start again from step 2.

5 Repeat steps 1 to 4 to preset another station.

Selecting a preset station

1 Press TUNER repeatedly to select the FM or AM band.

2 Press PRESET + or PRESET – repeatedly to select the preset station you want.

You can also press SHIFT and then press the numeric buttons to select the preset station you want. Then, press ⊕ to enter the selection.

You can also press TUNING MODE on the receiver repeatedly to select “PRESET”, then turn TUNING +/- to select the preset stations you want.

Listening to satellite tuner

For details on XM/SIRIUS Radio service, see “Listening to Satellite Radio” (page 74) in “Tuner Operations”.

Aiming the XM Radio or SIRIUS antenna

1 Press TUNER repeatedly to select “XM RADIO” or “SIRIUS”.

You can also use INPUT SELECTOR on the receiver.

2 Press AMP.

3 Press MENU.

4 Press ↑/↓ repeatedly to select “<TUNER>”.

5 Press ⊕ or → to enter the menu.

6 Press ↑/↓ repeatedly to select “XM ANT AIM” or “SR ANT AIM”.

7 Press ⊕ or → to enter the parameter.

8 While checking the parameter, aim your antenna to where the best reception will be received.

For details on the parameter, see “XM Signal Strength” or “SIRIUS Signal Strength” below.

XM Signal Strength

Signal strength	Signal type	
	Satellite	Terrestrial
GOOD	S : 3	T : 3
MARGINAL	S : 2	T : 2
WEAK	S : 1	T : 1
NO SIGNAL	S : 0	T : 0

SIRIUS Signal Strength

Signal Strength	Signal type	
	Satellite	Terrestrial
EXC (excellent)	S : 3	T : 3
GOOD	S : 2	T : 2
WEAK	S : 1	T : 1
NONE	S : 0	T : 0

Checking the Satellite Tuner ID

- 1 Press TUNER repeatedly to select “XM RADIO” or “SIRIUS”.
You can also use INPUT SELECTOR on the receiver.
- 2 Press TUNING + or TUNING – to select channel 0.
You can also press TUNING MODE on the receiver to select “AUTO”, then turn TUNING +/- to select channel 0.
- 3 Check the XM ID or SIRIUS ID on the display window and write it in the space provided here.
XM ID: _____
SIRIUS ID: _____

Selecting channels from a category (CATEGORY TUNING)

- 1 Press TUNER repeatedly to select “XM RADIO” or “SIRIUS”.
You can also use INPUT SELECTOR on the receiver.
- 2 Press CATEGORY MODE repeatedly to select “ONE CAT”.
 - ALL CAT: You can select a channel from all the categories. The initial setting is “ALL CAT”.
 - ONE CAT: You can select a channel from one category. “CAT” lights up on the display window when you set to “ONE CAT” mode.

- 3 Press CATEGORY + or CATEGORY – to select the category you want.
The category is selected and the channel with the lowest number in the specified category is selected.
- 4 Press TUNING + or TUNING – to select the channel.
You can also press TUNING MODE on the receiver to select “AUTO”, then turn TUNING +/- to select the channel.

Selecting a channel number directly (Direct tuning)

- 1 After selecting satellite tuner, press SHIFT and then press D.TUNING.
- 2 Press the numeric buttons to enter the channel number, then press \oplus to enter.

Displaying the satellite tuner information

Press DISPLAY repeatedly.

Each time you press DISPLAY while tuning in the channel, the display changes cyclically as follows:

Channel name → Channel number →
Category name → Artist name/Feature →
Song/Program title → Composer name
(SIRIUS only) → Signal strength → Sound
field → Volume level

Presetting satellite tuner channels

- 1 Select a channel you want to preset.**

For details on this operation, see “Selecting channels from a category (CATEGORY TUNING)”.
- 2 Press SHIFT and then press ENT/MEM.**

“MEM” lights up on the display window.
- 3 Press PRESET + or PRESET – to select a preset number.**

You can also select the number by pressing the numeric buttons. Preset numbers from 1 to 30 are available. Channel 1 is preset for the preset numbers when you purchase the receiver.
- 4 Press ENT/MEM.**
- 5 Repeat steps 1 to 4 to preset another station.**

Selecting a preset channel

- 1 Press TUNER repeatedly to select “XM RADIO” or “SIRIUS”.**
- 2 Press PRESET+ or PRESET – repeatedly to select the preset channel you want.**

You can also press SHIFT and then press the numeric buttons to select the preset channel you want. Then, press \oplus to enter the selection.

You can also press TUNING MODE on the receiver repeatedly to select “PRESET”, then turn TUNING +/- to select the preset channel you want.

Using the Remote

Operating each component using the multi function remote

You can control Sony or non-Sony components you are using with the multi function remote supplied with the receiver. The remote is initially set to control Sony components.

When you change the settings of the remote according to the components you are using, you can control non-Sony and other Sony components that the remote is initially unable control (page 124).

Operating the components connected to the receiver

- 1 Press the input button that matches the connected component that you want to operate.**
- 2 Press the appropriated buttons to use the function listed in the table below.**

Note

You may not be able to operate some functions for the components you are using.

Table of buttons used to control each component

Component	TV	VCR	DVD player, DVD/VHS combo	Blu-ray disc player	HDD recorder	PSX	Video CD player, LD player	Digital CATV terminal	DSS	Tape deck A/B	DAT deck	CD player, MD deck	DIGITAL MEDIA PORT device
Button													
AV I/⏻	●	●	●	●	●	●	●	●	●		●	●	
Numeric buttons (SHIFT mode)	●	●	●	●	●	●	●	●	●	●	●	●	●
TV INPUT, WIDE (SHIFT mode)	●												
-/-- (SHIFT mode)	●	●	●	●	●	●	●	●	●	●		●	
ENT/MEM (SHIFT mode)	●	●	●	●	●	●	● ^{b)}	●	●	●	●	●	
CLEAR (SHIFT mode)			●	●	●	●			●			●	
DISPLAY	●	●	●	●	●	●	●	●	●			●	
RETURN/EXIT ⏪	●		●	●	●	●	●	●	●				●
TOOLS/OPTIONS	●		●	●	●	●		●	●				
⏮/⏪/⏩/⏭, ⊕, MENU, HOME	●	●	●	●	●	●		●	●				●
⏮⏮/▶▶	●	●	●	●	●	●	●	●		● ^{d)}	●	●	●
⏮/▶	●		●	●	●	●		●					●
⏮/TUNING -, ▶▶/TUNING +	●	●	●	●	●	●	●	●		●	●	●	●
DISC SKIP			● ^{a)}	●			● ^{c)}					●	
▶, II, ■	●	●	●	●	●	●	●	●		●	●	●	●
MUTING, MASTER VOL +/-, TV VOL +/-	●												
PRESET +/-, TV CH +/-	●	●	●	●	●		● ^{b)}	●	●				
BD/DVD TOP MENU, BD/DVD MENU			●	●		●							
F1, F2			●	●									

a) DVD player only.

b) LD player only.

c) Video CD only.

d) Tape deck B only.

Programming the remote

You can customize the remote to match the components connected to your receiver. You can even program the remote to control non-Sony components and also Sony components that the remote is normally unable to control. The procedure below uses an example in which a VCR made by a company other than Sony is connected to the VIDEO 1 IN jacks on the receiver.

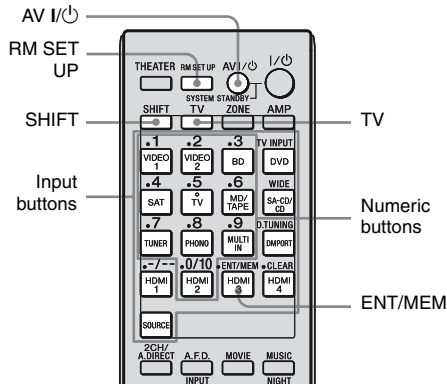

1 While holding down RM SET UP, press AV I/⏻.

The RM SET UP button flashes.

2 While the RM SET UP button is flashing, press the input button (including TV) for the component you want to control.

For example, if you are going to control a VCR connected to VIDEO 1 IN jack, press VIDEO1.

The RM SET UP and the SHIFT buttons light up. The input button you selected (VIDEO1) flashes.

If you press the button for a component of which you cannot program the remote, such as TUNER, PHONO, DMPORT or SOURCE, etc., the RM SET UP button keeps flashing.

3 Press the numeric buttons to enter the numeric code (or one of the codes if more than one code exists) corresponding to the component and the maker of the component you want to control.

The input button you selected in step 2 (VIDEO1) lights up. (The RM SET UP and SHIFT buttons remains lit.)

Note

For a TV remote code value, only numbers in the 500's are valid.

4 Press ENT/MEM.

Once the numeric code has been verified, the RM SET UP button flashes twice and the remote automatically exits the programming mode. The input button lights off.

To cancel programming

Press RM SET UP during any step.

The numeric codes corresponding to the component and the maker of the component

Use the numeric codes in the tables below to control non-Sony components and also Sony components that the remote is normally unable to control. Since the remote signal that a component accepts differs depending on the model and year of the component, more than one numeric code may be assigned to a component. If you fail to program your remote using one of the codes, try using other codes.

Notes

- The numeric codes are based on the latest information available for each brand. There is a chance, however, that your component will not respond to some or all of the codes.
- All of the input buttons on this remote may not be available when used with your particular component.

To control a CD player

Maker	Code(s)
SONY	101, 102, 103
DENON	104, 123
JVC	105, 106, 107
KENWOOD	108, 109, 110
MAGNAVOX	111, 116
MARANTZ	116
ONKYO	112, 113, 114
PANASONIC	115
PHILIPS	116
PIONEER	117
TECHNICS	115, 118, 119
YAMAHA	120, 121, 122

To control a DAT deck

Maker	Code(s)
SONY	203
PIONEER	219

To control an MD deck

Maker	Code(s)
SONY	301
DENON	302
JVC	303
KENWOOD	304

To control a tape deck

Maker	Code(s)
SONY	201, 202
DENON	204, 205
KENWOOD	206, 207, 208, 209
NAKAMICHI	210
PANASONIC	216
PHILIPS	211, 212
PIONEER	213, 214
TECHNICS	215, 216
YAMAHA	217, 218

To control an LD player

Maker	Code(s)
SONY	601, 602, 603
PIONEER	606

To control a video CD player

Maker	Code(s)
SONY	605

To control an HDD recorder

Maker	Code(s)
SONY	307, 308, 309

To control a VCR

Maker	Code(s)
SONY	701, 702, 703, 704, 705, 706
AIWA*	710, 750, 757, 758
AKAI	707, 708, 709, 759
BLAUPUNKT	740
EMERSON	711, 712, 713, 714, 715, 716, 750
FISHER	717, 718, 719, 720
GENERAL ELECTRIC (GE)	721, 722, 730
GOLDSTAR/LG	723, 753
GRUNDIG	724
HITACHI	722, 725, 729, 741
ITT/NOKIA	717
JVC	726, 727, 728, 736
MAGNAVOX	730, 731, 738
MITSUBISHI/MGA	732, 733, 734, 735
NEC	736
PANASONIC	729, 730, 737, 738, 739, 740
PHILIPS	729, 730, 731
PIONEER	729
RCA/PROSCAN	722, 729, 730, 731, 741, 747
SAMSUNG	742, 743, 744, 745
SANYO	717, 720, 746
SHARP	748, 749
TELEFUNKEN	751, 752
TOSHIBA	747, 756
ZENITH	754

* If an AIWA VCR does not work even though you enter the code for AIWA, enter the code for Sony instead.

To control a DVD player

Maker	Code(s)
SONY	401, 402, 403
BROKSONIC	424
DENON	405
HITACHI	416
JVC	415, 423
MITSUBISHI	419
ORITRON	417
PANASONIC	406, 408, 425
PHILIPS	407
PIONEER	409, 410
RCA	414
SAMSUNG	416, 422
TOSHIBA	404, 421
ZENITH	418, 420

To control a DVD recorder

Maker	Code(s)
SONY	401, 402, 403

To control a TV

Maker	Code(s)
SONY	501
AIWA	501, 536, 539
AKAI	503
AOC	503
CENTURION	566
CORONADO	517
CURTIS-MATHES	503, 551, 566, 567
DAYTRON	517, 566
DAEWOO	504, 505, 506, 507, 515, 544
FISHER	508, 545
FUNAI	548
FUJITSU	528
GOLDSTAR/LG	503, 512, 515, 517, 534, 544, 556, 568
GRUNDIG	511, 533, 534
HITACHI	503, 513, 514, 515, 517, 519, 544, 557, 571
ITT/NOKIA	521, 522
J.C.PENNY	503, 510, 566
JVC	516, 552
KMC	517
MAGNAVOX	503, 515, 517, 518, 544, 566
MARANTZ	527
MITSUBISHI/MGA	503, 519, 527, 544, 566, 568

Maker	Code(s)
NEC	503, 517, 520, 540, 544, 554, 566
NORDMENDE	530, 558
NOKIA	521, 522, 573, 575
PANASONIC	509, 524, 553, 559, 572
PHILIPS	515, 518, 557, 570, 571
PHILCO	503, 504, 514, 517, 518
PIONEER	509, 525, 526, 540, 551, 555
PORTLAND	503
QUASAR	509, 535
RADIO SHACK	503, 510, 527, 565, 567
RCA/PROSCAN	503, 510, 523, 529, 544
SAMSUNG	503, 515, 517, 531, 532, 534, 544, 556, 557, 562, 563, 566, 569
SAMPO	566
SABA	530, 537, 547, 549, 558
SANYO	508, 545, 546, 560, 567
SCOTT	503, 566
SEARS	503, 508, 510, 517, 518, 551
SHARP	517, 535, 550, 561, 565
SYLVANIA	503, 518, 566
THOMSON	530, 537, 547, 549
TOSHIBA	535, 539, 540, 541, 551
TELEFUNKEN	530, 537, 538, 547, 549, 558
TEKNIKA	517, 518, 567
WARDS	503, 517, 566
YORK	566
ZENITH	542, 543, 567
GENERAL ELECTRIC (GE)	503, 509, 510, 544
LOEWE	515, 534, 556

To control a satellite tuner (box)

Maker	Code(s)
SONY	801, 802, 803, 804, 824, 825, 865
AMSTRAD	845, 846
BskyB	862
GENERAL ELECTRIC(GE)	866
GRUNDIG	859, 860
HUMAX	846, 847
THOMSON	857, 861, 864, 876
PACE	848, 849, 850, 852, 862, 863, 864
PANASONIC	818, 855
PHILIPS	856, 857, 858, 859, 860, 864, 874
NOKIA	851, 853, 854, 864
RCA/PROSCAN	866, 871
HITACHI/BITA	868
HUGHES	867
JVC/EchoStar/Dish Network	873
MITSUBISHI	872
SAMSUNG	875
TOSHIBA	869, 870

To control a cable box

Maker	Code(s)
SONY	821, 822, 823
HAMLIN/REGAL	836, 837, 838, 839, 840
JERROLD/G.I./MOTOROLA	806, 807, 808, 809, 810, 811, 812, 813, 814, 819
JERROLD	830, 831
OAK	841, 842, 843
PANASONIC	816, 826, 832, 833, 834, 835
PHILIPS	830, 831
PIONEER	828, 829
RCA	805
SCIENTIFIC ATLANTA	815, 816, 817
TOCOM/PHILIPS	830, 831
ZENITH	826, 827

To control a Blu-ray disc player

Maker	Code(s)
SONY	310, 311, 312

To control a PSX

Maker	Code(s)
SONY	313, 314, 315

To control a DVD/VIDEO COMBO (recorder)

Maker	Code(s)
SONY	411

To control a HDD/DVD COMBO (recorder)

Maker	Code(s)
SONY	401, 402, 403

Performing several commands in sequence automatically

(Macro Play)

The Macro Play function lets you link several commands in a sequential order as a single command.

The remote provides 2 macro lists (MACRO 1 and MACRO 2). You can specify up to 20 commands for each macro list.

Note

When setting up Macro Play, replace the batteries with new ones.

Program the sequence of the operation

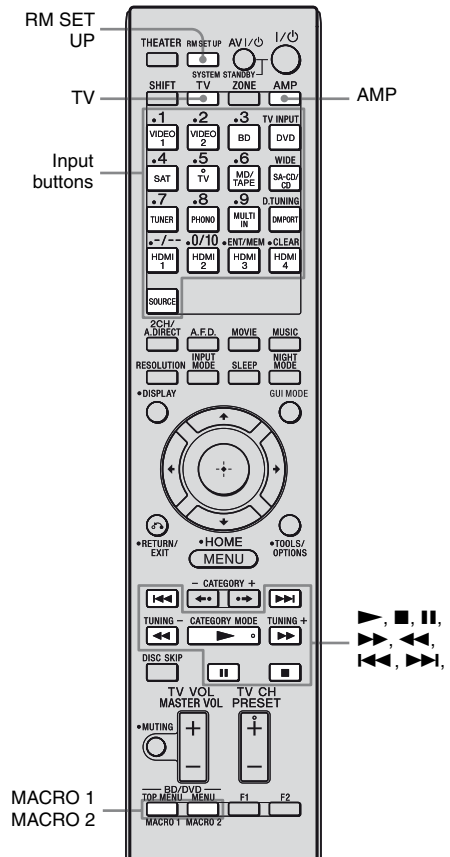

- 1** While holding down RM SET UP, press MACRO 1 or MACRO 2 for more than 1 second.

The RM SET UP button flashes and one of the input buttons lights up (in the initial setting, the VIDEO1 button lights up).

- 2** Press the input button of the component that you want to assign one of the following operations.

The selected input button lights up.

3 Press the button for the operation you want to perform to learn the function as follows.

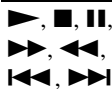
Press	Operations to be programmed
	Performs the operation of the button.
The input button for more than 1 second	Switches inputs.
MACRO 1 or MACRO 2	Make a one second interval. When you want to make a longer interval, press MACRO 1 or MACRO 2 repeatedly.

The input button selected in step 2 flashes twice, then lights up again.

4 Repeat steps 2 and 3. When you want to assign another command for the same component, repeat step 3.

5 Press RM SET UP to finish the programming process.

Tip

If the RM SET UP button flashes five times in step 1, and the macro programming process does not start, replace the batteries with new ones.

To cancel programming

Press RM SET UP. Also, not pressing any button for 60 seconds cancels the settings. The previous command remains valid.

Starting macro play

- 1 Press AMP.
The AMP button lights up, and then turns off.
- 2 Press MACRO 1 or MACRO 2 to start the macro.
The macro starts and execute the commands in the order you assigned them. While the commands are being sent, the AMP button flashes and the RM SET UP button lights up. When the commands have been sent, the RM SET UP and AMP buttons light off.

To erase a programmed macro

- 1 While holding down RM SET UP, press MACRO 1 or MACRO 2 for more than 1 second to clear the stored macro. The RM SET UP button flashes.
- 2 Press RM SET UP.
Settings stored as macro are cleared.

Setting remote control codes that are not stored in the remote

Even if a remote control code is not one of the presets stored in the remote, it is possible for the remote to learn the code using the learning function.

Note

When setting up the receiver to learn the remote command modes, replace the batteries with new ones.

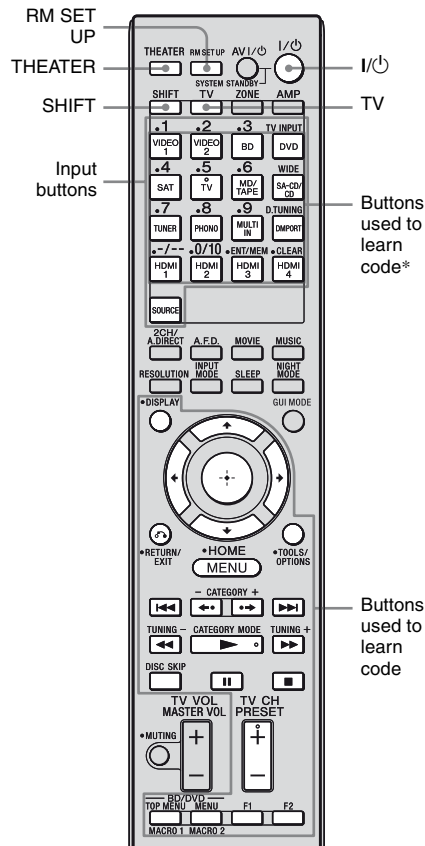

* To store a new command on one of those buttons, press SHIFT beforehand.

- 1 While holding down RM SET UP, press THEATER.
The RM SET UP button lights up.
- 2 Press the input button (including the TV button) for the component you want to operate with the new command.
The input button flashes. (The RM SET UP button remains lit.)
- 3 Press the button on which you want to store the new command. For the buttons with an asterisk in the illustration above, press SHIFT, then press the button.
The input button you selected in step 2 lights up. (The RM SET UP button remains lit.)
- 4 Point the remote code receiver section of the remote towards the receiver/transmitter on the remote control to be learned from.



About 5 cm - 10 cm (2" - 4")

- 5 Press the button on the remote commander to be learned from to transmit the remote code.
While the remote of the receiver is receiving the signal, the input button selected in step 2 turns off. The RM SET UP button flashes twice, then the learning process is completed. When the learning process fails, the RM SET UP button flashes five times. Try to perform the process again from step 2.

6 Press RM SET UP to finish the Learning function process.

Tips

- When the memory capacity for storing remote control codes reaches a certain limit, the RM SET UP button flashes 10 times, and then the learning process ends.
- If the RM SET UP button flashes five times in step 1, and the learning process does not start, replace the batteries with new ones.

To cancel learning

Press RM SET UP. Also, not pressing any button for 60 seconds cancels the settings.

Using a command that has been learned

When selecting a learned input, press the button used to learn that function.

To erase the learned code

- 1 While holding down RM SET UP, press THEATER.
- 2 Press the input button (VIDEO 1 in the example) for which you want to clear the setting.
The input button flashes. (The RM SET UP button remains lit.)
- 3 Press I/⏻ for more than 1 second.
The input button flashes twice.
- 4 Press SHIFT, then press numeric buttons to clear the stored setting.
The RM SET UP button flashes twice, then the clearing process is completed.
When the clearing process fails, the RM SET UP button flashes five times. Try to perform the process again from step 2.

Clearing all the contents of the remote's memory

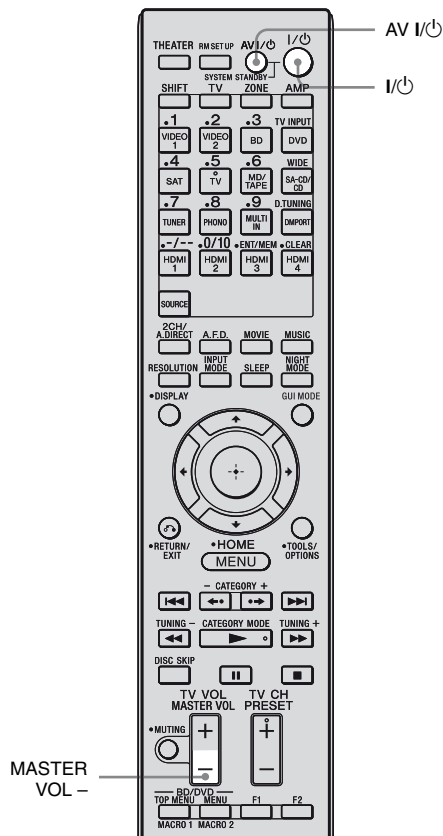

- 1 Press and hold MASTER VOL – first, then press I/⏻, then press AV I/⏻.

The RM SET UP button flashes three times.

- 2 Release all buttons.

All the contents of the remote's memory (i.e., all the programmed data) are cleared.

Glossary

■ Component video

A format for transmitting video signal information consisting of three separate signals: luminance Y, chrominance Pb, and chrominance Pr. High quality pictures, such as DVD video or HDTV pictures, are transmitted more faithfully. The three jacks are color-coded green, blue, and red.

■ Composite video

A standard format for transmitting video signal information. The luminance signal Y and chrominance signal C are combined and transmitted together.

■ Crossover frequency

The frequency at which two speaker's frequencies intersect.

■ Deep Color (Deep Colour)

Video signals for which the color depth of signals passing through an HDMI jack have been raised.

The number of colors that could be expressed by 1 pixel was 24 bits (16,777,216 colors) with the current HDMI jack. However, the number of colors which can be expressed by 1 pixel will be 36, etc., bits when the receiver corresponds to Deep Color (Deep Colour). Since the gradation of the depth of a color can be expressed more finely with more bits, continuous color changes can be more smoothly expressed.

■ Dolby Digital

Digital audio encoding/decoding technology developed by Dolby Laboratories, Inc. It consists of front (left/right), center, surround (left/right) and subwoofer channels. It is a designated audio standard for DVD-video and also known as 5.1 channels surround.

■ Dolby Digital Plus

Dolby Digital Plus provides the flexibility and efficiency to deliver more channels of compelling surround sound for high-definition video media. Its superior coding efficiencies enable up to 7.1 channels of high-quality multi channel audio without negatively impacting bit budgets allocated for video performance or additional feature sets.

■ Dolby Digital Surround EX

Acoustic technology developed by Dolby Laboratories, Inc. Surround back information is matrixed into regular left and right surround channels so that the sound can be reproduced in 6.1 channels. Active scenes, especially, are recreated with a more dynamic and realistic sound field.

■ Dolby Pro Logic II

This technology converts 2 channels stereo recorded audio into 5.1 channels for playback. There is a MOVIE mode for movies and MUSIC mode for stereo sources such as music. Old movies encoded in the traditional stereo format can be enhanced with 5.1 channels surround sound. The GAME mode is suitable for video games.

■ Dolby Pro Logic Ix

Technology for 7.1 channels (or 6.1 channels) playback. Along with audio encoded in Dolby Digital Surround EX, 5.1 channels Dolby Digital encoded audio can be reproduced in 7.1 channels (or 6.1 channels). Furthermore, existing stereo recorded content can also be reproduced in 7.1 channels (or 6.1 channels).

■ Dolby Surround (Dolby Pro Logic)

Audio processing technology developed by Dolby Laboratories, Inc. Center and mono surround information is matrixed into two stereo channels. When reproduced, audio is decoded and output in 4 channels surround sound. This is the most common audio processing method for DVD-video.

■ **Dolby TrueHD**

Dolby TrueHD is Dolby's lossless audio technology developed for high-definition optical discs. Dolby TrueHD audio is bit-for-bit identical to the original studio masters and provides supreme-quality audio up to 8 channels at 96 kHz/24 bit and up to 6 channels at 192 kHz/24 bit. Together with high-definition video, it offers an unprecedented home theater experience.

■ **DTS 96/24**

A high sound quality digital signal format. It records audio at a sampling frequency and bit rate of 96 kHz/24 bit which is the highest possible for DVD-video. The number of playback channels varies depending on the software.

■ **DTS Digital Surround**

Digital audio encoding/decoding technology for theaters developed by DTS, Inc. It compresses audio less than Dolby Digital, delivering a higher quality sound reproduction.

■ **DTS-ES**

Format for 6.1 channels playback with surround back information. There are two modes, "Discrete 6.1" which records all channels independently, and "Matrix 6.1" which matrixes surround back channel into surround left and surround right channels. It is ideal for playback of motion picture soundtracks.

■ **DTS-HD**

Audio format which extends the conventional DTS Digital Surround format. This format consists of a core and an extension, and the core part has DTS Digital Surround compatibility. There are two kinds of DTS-HD, DTS-HD High Resolution Audio and DTS-HD Master Audio. DTS-HD High Resolution Audio has a maximum transmission rate of 6 Mbps, with lossy compression (Lossy), and DTS-HD High Resolution Audio corresponds to a maximum sampling frequency of 96 kHz, and a maximum of 7.1 channels. DTS-HD Master Audio has a maximum transmission rate of 24.5 Mbps, and uses lossless compression (Lossless), and DTS-HD Master Audio corresponds to a maximum sampling frequency of 192 kHz, and a maximum of 7.1 channels.

■ **DTS Neo:6**

This technology converts 2 channels stereo recorded audio for 7 channels playback. There are two modes to select according to the playback source or your preference, CINEMA for movies, and MUSIC for stereo sources such as music.

■ **HD Digital Cinema Sound**

HD Digital Cinema Sound (HD-D.C.S.) is Sony's new innovative home theater technology using the latest acoustic and digital signal processing technologies. It is based on precise response measurement data of a mastering studio.

With HD-D.C.S., you are able to enjoy Blu-ray and DVD movies at home with not only the high quality of sound, but also the best sound ambience, just as the movie's sound engineer intended in the mastering process.

■ HDMI (High-Definition Multimedia Interface)

HDMI (High-Definition Multimedia Interface) is an interface that supports both video and audio on a single digital connection, allowing you to enjoy high quality digital picture and sound. The HDMI specification supports HDCP (High-bandwidth Digital Contents Protection), a copy protection technology that incorporates coding technology for digital video signals.

■ High Bitrate Audio

It refers to the audio formats of the compression method (DTS-HD Master Audio, Dolby TrueHD, etc.) which is a high bitrate format recorded mainly on Blu-ray disc, etc.

■ Interlace

A scanning method which completes a picture by displaying half of the lines on a tube surface of a TV or monitor each 1/60 second. First, all the odd-numbered lines are drawn, leaving spaces between each line, then all the even-numbered lines are drawn to fill the spaces. “i” of “480i” stands for “Interlace”.

■ L.F.E. (Low Frequency Effects)

Sound effects of low frequencies which are output from a subwoofer in Dolby Digital or DTS, etc. By adding a deep bass with a frequency between 20 to 120 Hz, audio becomes more powerful.

■ Neural-THX

Neural-THX[®] Surround is taking surround sound to the next level. This revolutionary new technology delivers the rich envelopment and discrete image detail of surround sound in a format that is fully compatible with stereo. Neural-THX Surround reduces the bandwidth needed for broadcasters to deliver true, multi channel surround presentations, and enables 7.1-channel support for gaming and movies. By unmasking the audio details, typically lost by other playback systems, audiences will experience the deep ambience and subtle details of movies, music and games. And with this technology being used by sound designers during content creation, as well as embedded into playback devices, Neural-THX Surround promises a listening experience that is true to the original mix. Neural-THX Surround has been chosen as the official surround sound broadcast format for XM Satellite Radio’s “XM HD Surround”, as well as other leading FM/HD radio stations worldwide. For additional information, please visit www.neuralsurround.com.

■ PCM (Pulse Code Modulation)

A method of converting analog audio to digital audio for easy enjoyment of digital sound.

■ Progressive

A scanning method that draws all scanning lines sequentially, as opposed to interlaced scanning where all the odd and then all the even lines are drawn. “p” of “480p” stands for “Progressive”.

■ x.v.Color (x.v.Colour)

x.v.Color (x.v.Colour) is a more familiar term for the xvYCC standard proposed by Sony, and is a trademark of Sony. xvYCC is an international standard for color space in video. This standard can express a wider color range than the currently used broadcast standard.

Precautions

On safety

Should any solid object or liquid fall into the cabinet, unplug the receiver and have it checked by qualified personnel before operating it any further.

On power sources

- Before operating the receiver, check that the operating voltage is identical with your local power supply.
The operating voltage is indicated on the nameplate on the back of the receiver.
- The unit is not disconnected from the AC power source (mains) as long as it is connected to the wall outlet, even if the unit itself has been turned off.
- If you are not going to use the receiver for a long time, be sure to disconnect the receiver from the wall outlet. To disconnect the AC power cord (mains lead), grasp the plug itself; never pull the cord.
- One blade of the plug is wider than the other for the purpose of safety and will fit into the wall outlet only one way. If you are unable to insert the plug fully into the outlet, contact your dealer.
- AC power cord (mains lead) must be changed only at a qualified service shop.

On heat buildup

Although the receiver heats up during operation, this is not a malfunction. If you continuously use this receiver at a large volume, the cabinet temperature of the top, side and bottom rises considerably. To avoid burning yourself, do not touch the cabinet.

On placement

- Place the receiver in a location with adequate ventilation to prevent heat buildup and prolong the life of the receiver.
- Do not place the receiver near heat sources, or in a place subject to direct sunlight, excessive dust, or mechanical shock.
- Do not place anything on top of the cabinet that might block the ventilation holes and cause malfunctions.
- Do not place the receiver near equipment such as a television, VCR, or tape deck. (If the receiver is being used in combination with a television, VCR, or tape deck, and is placed too close to that equipment, noise may result, and picture quality may suffer. This is especially likely when using an indoor antenna (aerial). Therefore, we recommend using an outdoor antenna (aerial).)
- Use caution when placing the receiver on surfaces that have been specially treated (with wax, oil, polish, etc.) as staining or discoloration of the surface may result.

On operation

Before connecting other components, be sure to turn off and unplug the receiver.

On cleaning

Clean the cabinet, panel, and controls with a soft cloth slightly moistened with a mild detergent solution. Do not use any type of abrasive pad, scouring powder, or solvent, such as alcohol or benzine.

If you have any questions or problems concerning your receiver, please consult your nearest Sony dealer.

Troubleshooting

If you experience any of the following difficulties while using the receiver, use this troubleshooting guide to help you remedy the problem. Should any problem persist, consult your nearest Sony dealer.

Audio

There is no sound, no matter which component is selected, or only a very low-level sound is heard.

- Check that the speakers and components are connected securely.
- Check that all speaker cords are connected correctly.
- Check that both the receiver and all components are turned on.
- Check that MASTER VOLUME control is not set at VOL ∞ dB. Try to set it at about VOL -40.0 dB.
- Check that SPEAKERS (OFF/A/B/A+B) is not set to off (page 44).
- Press MUTING on the remote to cancel the muting function.
- Check that you have selected the correct component with INPUT SELECTOR.
- Check that headphones are not connected.
- When only a very low-level sound is heard, check to see if NIGHT MODE is activated (page 65).
- The protective device on the receiver has been activated. Turn off the receiver, eliminate the short-circuit problem, and turn on the power again.

There is no sound from a specific component.

- Check that the component is connected correctly to the audio input jacks for that component.
- Check that the cord(s) used for the connection is (are) fully inserted into the jacks on both the receiver and the component.

There is no sound from one of the front speakers.

- Connect a pair of headphones to the PHONES jack to verify that sound is output from the headphones. If only one channel is output from the headphones, the component may not be connected to the receiver correctly. Check that all the cords are fully inserted into the jacks on both the receiver and the component. If both channels are output from the headphones, the front speaker may not be connected to the receiver correctly. Check the connection of the front speaker which is not outputting any sound.
- Make sure you have connected both the L or R jack to an analog component and not just to either the L or R jack. Use an audio cord (not supplied).

There is no sound from analog 2 channel sources.

- Check that INPUT MODE is set to “ANALOG” (page 102).

There is no sound from digital sources (from COAXIAL or OPTICAL input jack).

- Check that INPUT MODE is not set to “ANALOG” (page 102).
- Check that “2ch Analog Direct” is not being used.
- Check to make sure the selected digital audio input jack is not assigned to other inputs in “Input Assign” in the Input menu (page 102).

The left and right sounds are unbalanced or reversed.

- Check that the speakers and components are connected correctly and securely.
- Adjust the level parameters using the Speaker settings menu.

There is severe hum or noise.

- Check that the speakers and components are connected securely.
- Check that the connecting cords are away from a transformer or motor, and at least 10 feet (3 meters) away from a TV set or fluorescent light.
- Move your audio components away from the TV.
- Make sure you have grounded the \hbar SIGNAL GND terminal (only when a turntable is connected).
- The plugs and jacks are dirty. Wipe them with a cloth slightly moistened with alcohol.

There is no sound, or only a very low-level sound is heard from the center/surround/surround back speakers.

- Select the “HD-D.C.S.” sound field (page 63).
- Adjust the speaker level (page 65).

There is no sound from the surround back speakers.

- Some discs have no Dolby Digital Surround EX flag even though the packages have Dolby Digital Surround EX logos.

There is no sound from the subwoofer.

- Check that the subwoofer is connected correctly and securely.
- Make sure you have turned on your speaker.
- When all speakers are set to “LARGE” and “Neo:6 Cinema” or “Neo:6 Music” is selected, there is no sound from the subwoofer.

The surround effect cannot be obtained.

- Make sure the sound field function is on (press MOVIE or MUSIC).
- Sound fields do not function for signals with a sampling frequency of 88.2 kHz and higher.

Dolby Digital or DTS multi channel sound is not reproduced.

- Check that the DVD, etc. you are playing is recorded in Dolby Digital or DTS format.
- When connecting the DVD player, etc., to the digital input jacks of this receiver, make sure the setting for the digital audio output of the connected component is available.

Recording cannot be carried out.

- Check that the components are connected correctly (page 20).
- Select the source component using INPUT SELECTOR (page 50).

The MULTI CHANNEL DECODING lamp does not light up in blue.

- Check that the playback component is connected on a digital jack and the input is selected properly on this receiver.
- Check whether the input source of the software being played back corresponds to the multi channel format.
- Check whether the setup on the playback component is set to multi channel sound.
- Check to make sure the selected digital audio input jack is not assigned to other inputs in “Input Assign” in the Input menu (page 102).

There is no sound from the component connected to the DIGITAL MEDIA PORT adapter.

- Adjust the volume of this receiver.
- The DIGITAL MEDIA PORT adapter and/or component is not connected correctly. Turn off the receiver, then reconnect the DIGITAL MEDIA PORT adapter and/or component.
- Check the DIGITAL MEDIA PORT adapter and/or component device to make sure it supports this receiver.

Video

There is no picture or an unclear picture appears on the TV screen.

- Select the appropriate input on the receiver (page 50).
- Set your TV to the appropriate input mode.
- Move your audio components away from the TV.
- Assign the video input correctly.
- The input signal should be same as input when you are up-converting an input signal with this receiver (page 33).

The image of the COMPONENT VIDEO OUT is corrupted.

- Video input signals other than 480p component are not received when signals are output from the VIDEO jack. Input 480i component video signals.
- When component input signals other than 480p are output, use the COMPONENT VIDEO MONITOR OUT jack and set “Resolution” to “DIRECT”.

Recording cannot be carried out.

- Check that the components are connected correctly (page 25).
- Select the source component using INPUT SELECTOR (page 50).

The GUI does not appear on the TV screen.

- Press GUI MODE repeatedly to select “GUI ON”. Press MENU if the GUI menu does not appear on the TVscreen.
- Check that the TV is connected correctly.

HDMI

The source sound input to the HDMI jack is not output from the receiver or the TV speaker.

- Check the HDMI connection (page 85).
- You cannot listen to the DSD signals of Super Audio CD by connecting HDMI.
- Depending on the playback component, you may need to set up the component. Refer to the operating instructions supplied with each component.
- Be sure to use a connecting cable for the HDMI jack corresponding to high speed (an HDMI version 1.3a, category 2 cable) when you view images or listen to sound during a 1080p or Deep Color (Deep Colour) transmission.

The source image input to the HDMI jack is not output from the TV.

- Check the HDMI connection (page 85).
- Depending on the playback component, you may need to set up the component. Refer to the operating instructions supplied with each component.
- Be sure to use a connecting cable for the HDMI jack corresponding to high speed (an HDMI version 1.3a, category 2 cable) when you view images or listen to sound during a 1080p or Deep Color (Deep Colour) transmission.

The Control for HDMI function does not work.

- Check the HDMI connection (page 85).
- Make sure “Control for HDMI” is set to “ON” in the HDMI settings menu.
- Make sure the connected component is compatible with the Control for HDMI function.
- Check the Control for HDMI settings on the connected component. Refer to the operating instructions of the connected component.
- If you change the HDMI connection, connect/disconnect the AC power cord, or there is a power failure, repeat the procedures of “Preparing Control for HDMI function” (page 86).

No sound is output from the receiver and TV speaker while using the System Audio Control function.

- Make sure the TV is compatible with the System Audio Control function.
- If the TV does not have System Audio Control function, set the “Audio Out” settings in HDMI settings menu to
 - “TV+AMP” if you want to listen to the sound from the TV speaker and receiver.
 - “AMP” if you want to listen to the sound from the receiver.
- When you connect the receiver to a video component (projector, etc.), sound may not be output from the receiver. In this case, select “AMP”.
- If you cannot listen to the sound of a component connected to the receiver
 - Change the input of the receiver to HDMI when you want to watch a program on a component connected via HDMI connection to the receiver.
 - Change the TV channel when you want to watch a TV broadcast.
 - Select the component or input you want to watch when you watch a program on the component connected to the TV. Refer to the operating instructions of the TV on this operation.

- When using the Control for HDMI function, you cannot control the connected component using TV’s remote.
 - Depending on the connected component and TV, you may need to set up the component and TV. Refer to the operation instructions supplied with each component and TV.
 - Change the input of the receiver to the HDMI input connected to the component.

The TV’s remote commander cannot be used to control the connected component when using the Control for HDMI function.

- Change the input of the receiver to the HDMI input connected to the component.

Tuner

The FM reception is poor.

- Use a 75-ohm coaxial cable (not supplied) to connect the receiver to an outdoor FM antenna (aerial) as shown below. If you connect the receiver to an outdoor antenna (aerial), ground it against lightning. To prevent a gas explosion, do not connect the ground (earth) wire to a gas pipe.

Outdoor FM antenna (aerial)

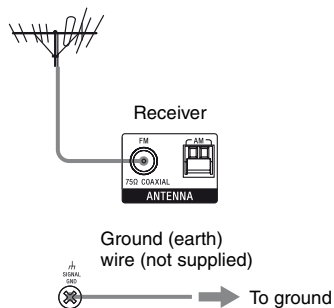

Radio stations cannot be tuned in.

- Check that the antennas (aerials) are connected securely. Adjust the antennas (aerials) and connect an external antenna (aerial), if necessary.
- Keep the satellite radio antenna, away from the speaker cords and the power cord (mains lead) to avoid picking up noise.
- The signal strength of the stations is too weak (when tuning in with automatic tuning). Use direct tuning.
- Make sure you set the tuning interval correctly (when tuning in AM stations with direct tuning).
- No stations have been preset or the preset stations have been cleared (when tuning by scanning preset stations). Preset the stations (page 73).
- Press DISPLAY so that the frequency appears on the display window.

The system cannot receive satellite channels at all.

- The receiving condition is not good. Move the antenna to the place where the condition is good.
- Check that you subscribed to the desired satellite radio service (see page 74).

Remote control

The remote does not function.

- Point the remote at the remote sensor on the receiver.
- Remove any obstacles in the path between the remote and the receiver.
- Replace all the batteries in the remote with new ones, if they are weak.
- Make sure that the command modes of the receiver and the remote are the same. If the command mode of the receiver and the remote are different, you cannot operate the receiver with the remote (page 38).
- Make sure you select the correct input on the remote.
- When you operate a programmed non-Sony component, the remote may not function properly depending on the model and the maker of the component.

Error messages

If there is a malfunction, the display window shows a message. You can check the condition of the system by the message. See the following table to solve the problem. If any problem persists, consult your nearest Sony dealer.

PROTECTOR

Irregular current is output to the speakers, or the upper panel of the receiver is covered with something. The receiver will automatically turn off after a few seconds. Check the connection of speakers and turn on the power again.

For other messages, see “Message list after Auto Calibration measurement” (page 49), “XM Radio message list” (page 82), “SIRIUS Satellite Radio message list” (page 83) and “DIGITAL MEDIA PORT message list” (page 100).

Reference sections for clearing the receiver's memory

To clear	See
All memorized settings	page 37
Customized sound fields	page 64

Specifications

AUDIO POWER SPECIFICATIONS

POWER OUTPUT AND TOTAL HARMONIC DISTORTION:

With 8 ohms loads, both channels driven, from 20 Hz – 20,000 Hz; rated 100 watts per channel minimum RMS power, with no more than 0.09% total harmonic distortion from 250 milliwatts to rated output.

Amplifier section

Power Output

Rated Power Output at Stereo Mode¹⁾

(8 ohms 20 Hz – 20 kHz, THD 0.09%):
100 W + 100 W

Reference Power Output at Stereo Mode

(4 ohms 20 Hz – 20 kHz, THD 0.15%):
85 W + 85 W

Reference Power Output (8 ohms 1 kHz, THD 0.7%)

FRONT²⁾: 110 W + 110 W

CENTER²⁾: 110 W

SURROUND²⁾: 110 W + 110 W

SURROUND BACK²⁾:
110 W + 110 W

Reference Power Output (4 ohms 1 kHz, THD 0.7%)

FRONT²⁾: 100 W + 100 W

CENTER²⁾: 100 W

SURROUND²⁾: 100 W + 100 W

SURROUND BACK²⁾:
100 W + 100 W

¹⁾Depending on the sound field settings and the source, there may be no sound output.

²⁾Measured under the following conditions:

Power requirements: 120 V AC, 60 Hz

Frequency response

PHONO RIAA equalization curve
±0.5 dB

Analog 10 Hz – 100 kHz,
±3 dB (with sound field
and equalizer bypassed)

Input	
PHONO	Sensitivity: 2.5 mV Impedance: 50 kohms S/N ³⁾ : 90 dB (A, 20 kHz LPF) ⁴⁾
Analog	Sensitivity: 150 mV/ 50 kohms S/N ³⁾ : 100 dB (A, 20 kHz LPF) ⁴⁾
Digital (Coaxial)	Impedance: 75 ohms S/N: 96 dB (A, 20 kHz LPF) ⁴⁾
Digital (Optical)	S/N: 96 dB (A, 20 kHz LPF) ⁴⁾
Output (analog)	
AUDIO OUT	Voltage: 150 mV/ 1 kohm
SUBWOOFER	Voltage: 2 V/1 kohm
Equalizer	
Gain levels	±10 dB, 1 dB step

³⁾INPUT SHORT (with sound field and equalizer bypassed).
⁴⁾Weighted network.

FM tuner section

Tuning range	87.5 – 108.0 MHz
Antenna (aerial)	FM wire antenna (aerial)
Antenna (aerial) terminals	75 ohms, unbalanced
Intermediate frequency	10.7 MHz

AM tuner section

Tuning range	
With 10-kHz tuning scale	530 – 1,710 kHz ⁵⁾
With 9-kHz tuning scale	531 – 1,710 kHz ⁵⁾
Antenna (aerial)	Loop antenna (aerial)
Intermediate frequency	450 kHz

⁵⁾You can change the AM tuning scale to either 9 kHz or 10 kHz. After tuning in any AM station, turn off the receiver. While holding down TUNING MODE, press POWER on the receiver. All preset stations will be erased when you change the tuning scale. To reset the scale to 10 kHz (or 9 kHz), repeat the procedure.

Video section

Inputs/Outputs	
Video:	1 Vp-p, 75 ohms
COMPONENT VIDEO:	
Y:	1 Vp-p, 75 ohms
P _B /C _B :	0.7 Vp-p, 75 ohms
P _R /C _R :	0.7 Vp-p, 75 ohms
	80 MHz HD Pass Through

HDMI Video

Input/Output (HDMI Repeater block)	
	640 × 480p@60 Hz
	720 × 480p@59.94/60 Hz
	1280 × 720p@59.94/60 Hz
	1920 × 1080i@59.94/60 Hz
	1920 × 1080p@59.94/60 Hz
	720 × 576p@50 Hz
	1280 × 720p@50 Hz
	1920 × 1080i@50 Hz
	1920 × 1080p@50 Hz
	1920 × 1080p@24 Hz

General

Power requirements	120 V AC, 60 Hz
Power output (DIGITAL MEDIA PORT)	
DC OUT:	5 V, 0.7A MAX
Power consumption	350 W
Power consumption (during standby mode)	
	0.9 W (when “Control for HDMI” and “Installer Mode” are set to “OFF”, and the power for zone 2/ zone 3 is turned off.)
Dimensions (width/height/depth) (Approx.)	
	17 × 6 1/4 × 15 3/8 inches (430 x 157.5 x 388 mm) including projecting parts and controls
Mass (Approx.)	27 lb 6 oz (12.4 kg)

Supplied accessories

Operating Instructions (this manual)

Quick Setup Guide (1)

GUI Menu List (1)

Optimizer microphone (ECM-AC2) (1)

FM wire antenna (aerial) (1)

AM loop antenna (aerial) (1)

AC power cord (mains lead) (1)

Multi function remote commander (1)

Simple remote commander (1)

R6 (size-AA) batteries (4)

Design and specifications are subject to change without notice.

Halogenated flame retardants are not used in the certain printed wiring boards.

Index

Symbols

⌚ SIGNAL GND terminal 24

Numerics

2 channel 60

24p Auto Sound Sync 58

2ch Analog Direct 60, 119

2ch Stereo Mode 60

4 Ω 43

5.1 channel 15

7.1 channel 15

8 Ω 43

A

A.F.D. (mode) 62

A/V Sync 56, 116

AC power cord (mains lead) 37

AM 71, 105, 119

Audio (Settings) 56, 116

Auto Calibration 44, 113, 117

Auto Tuning 71, 119

B

BI-AMP 69

Bi-amplifier connection 110

Blu-ray disc player 27, 53

C

Calibration Type Select 48, 113

Category Mode 77, 121

CD player 21, 24, 52

Changing the display 105

Clear

memory 37

remote 131

Command mode 38

Connections

antennas (aerials) 36

audio components 20

speakers 17

video components 25

Control for HDMI

connecting 85

preparing 86

Crossover Freq 69

D

D.Range Comp (Dynamic range compressor)
70

DCAC (Digital Cinema Auto Calibration) 44

Decode Priority 56, 116

DIGITAL MEDIA PORT 10, 14, 21, 97

Direct Tuning 72, 78, 119, 121

Display 106

Distance 66

Distance Unit 70, 114

Dolby Digital EX 61

DTS Neo:6 (Cinema, Music) 62

Dual Mono 56, 116

DVD player 27, 29, 53

DVD recorder 32

E

Effect Type 115

Enhanced Setup 50

Enhanced Surround mode 59, 119

EQ (Settings) 70, 115

EQ Curve 50

Equalizer 70

F

FM 71, 105, 119
FM Mode 72, 115

G

Gain Adjusting (Bass/Treble) 70
GUI (Graphical User Interface) 19, 40

H

HD-D.C.S. 133
HDMI (Settings) 86, 116
HDMI jacks 9, 26
Headphone (Settings) 63

I

Input 50
Input Assign 103
INPUT MODE 101
INPUT SELECTOR 52, 53, 54, 55
Installer Mode 58, 116
iPod 98

L

Level 66, 70
LFE (Low Frequency Effect) 106
List Mode 100
Lock Code 81, 115

M

Manual Setup 65, 66
MASTER VOLUME 8, 52, 53, 54, 55
Messages
 Auto Calibration 49
 DIGITAL MEDIA PORT 100
 error 140
 SIRIUS 83
 XM 82
Movie 63
MULTI CHANNEL DECODING lamp 53
Music 63
Muting 51

N

Name Input 101
Network Client 98
Neural-THX 62
NIGHT MODE 65

O

One-Touch Play 87

P

Parental Lock 80, 115
Phase Audio 69, 113
Phase Noise 69, 113
PHONES 8
PLII 62
PLIIx 62
Position (Auto Calibration) 50, 113
Preset channels 79, 122
Preset Mode 79
Preset stations 73, 120
PROTECTOR 140

Q

Quick Setup 46

R

Radio ID 76, 115, 121
Recording 109, 110
Remote 11–14, 38, 122–131
Resetting 37, 64
Resolution 57, 96, 116

S

Satellite radio 74
Screen Saver 58
Sleep timer 108
Sound Field Select 59, 119
Sound Field Setup 59
Speaker (Settings) 43, 69, 114
Speaker Impedance 43, 114
Speaker Pattern 67, 114
SPEAKERS (OFF/A/B/A+B) 8, 44
Super Audio CD player 21, 23, 24, 52
Sur Back Assign 69
Surround Settings 115
System (Settings) 58, 116
System Audio Control 88
System Power Off 88

T

Test Tone 68, 69, 113
Tuner 71
Tuner (Settings) 115
Tuning 71, 72, 73

U

Up converting 33

V

VCR 32, 55
Video (Settings) 57, 116
Video game 54

Z

Zone 12V Trigger 94, 116
ZONE 2 69
ZONE 3 10
Zone Input Change 94
Zone Power ON/OFF 94
Zone Volume Adjust 94



* 4 1 4 4 9 0 7 1 1 * (1)

Sony Corporation Printed in Malaysia

<http://www.sony.net/>